

REV.	ECN NO.	DESCRIPTION	DESIGN	DATE
A		INITIAL	Kai	2018.03.29

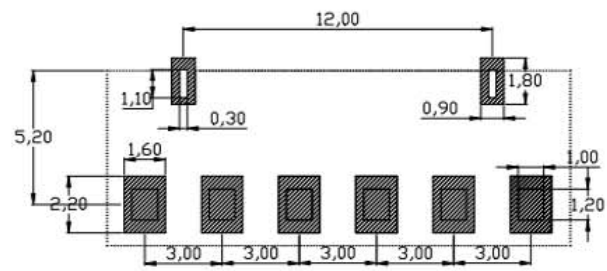
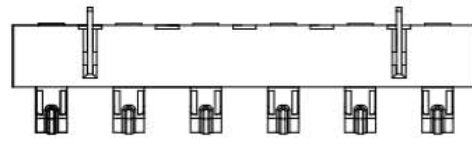
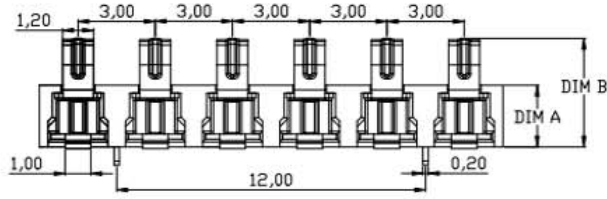
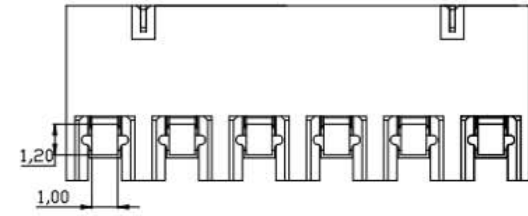
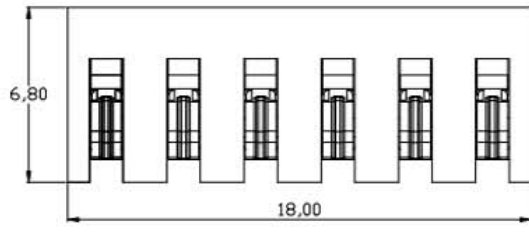
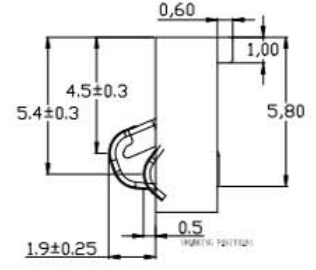
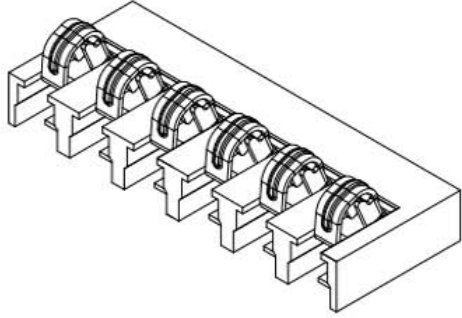

RECOMMENDED PCB LAYOUT
TOP VIEW (.XX±0.05)

性能:
 额定电流: 3.0A
 额定电压: 24V
 耐电压: 500V
 接触电阻: 30mΩ MAX
 绝缘电阻: 500MΩ
 工作温度: -40℃~+85℃
 塑件(材质): LCP, 耐高温260℃
 接触点(材质): 铜合金, 触点镀金3U'

UNLESS OTHERWISE SPECIFIED TOLERANCES				广东科斯达电器开关厂			
DECIMALS:		ANGLES:		DWG NO.	PART NAME:		
DIM	TOL	DIM	TOL	DESIGN:	PART NO.		
X.	±0.50	X.	±2'	CHECK:	REV. UNIT: SHEET:		
X.X	±0.30	X.X	±1'	APPROVED	A	mm	1/1
X.XX	±0.20	X.XX	---				
X.XXX	±0.10	X.XXX	---				

②	HOUSING	1	LCP		BLACK
①	CONTACT A	2	PHOSPHOR BRONZE 0.20T	Au PLATED	
ITEM	PART NAME	Q'TY	MATERIAL	DESCRIPTION	REMARK