

REV.	ECN NO.	DESCRIPTION	DESIGN	DATE
A		INITIAL	Kai	2018.03.29

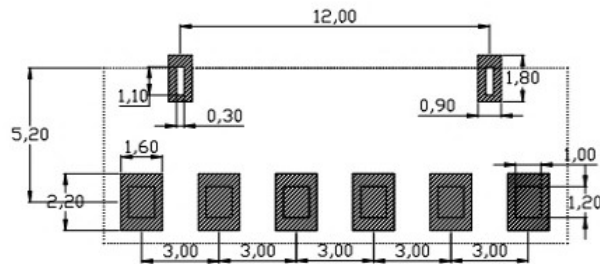
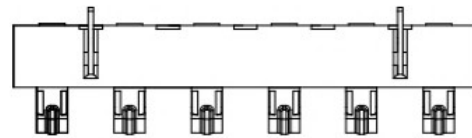
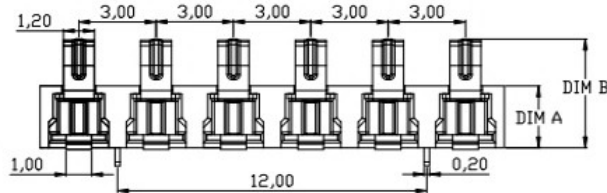
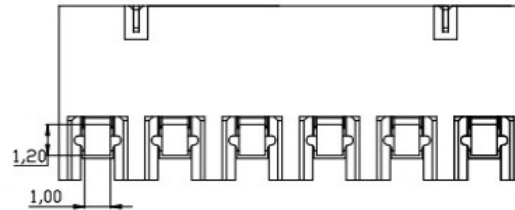
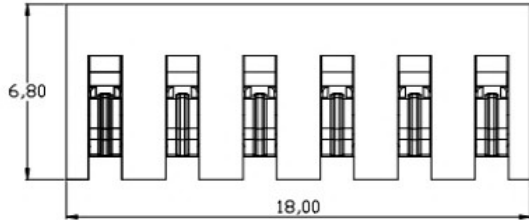
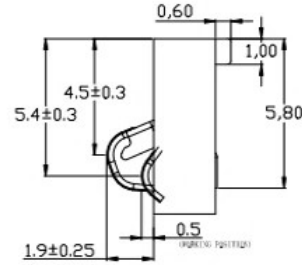
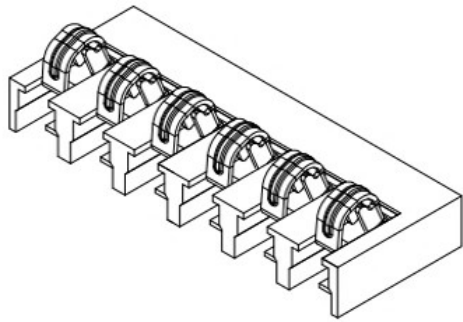

RECOMMENDED PCB LAYOUT
TOP VIEW (.XX±0.05)

性能:
 额定电流: 3.0A
 额定电压: 24V
 耐电压: 500V
 接触电阻: 30mΩ MAX
 绝缘电阻: 500MΩ
 工作温度: -40℃~+85℃
 塑件(材质): LCP, 耐高温260℃
 接触点(材质): 铜合金, 触点镀金3U'

UNLESS OTHERWISE SPECIFIED TOLERANCES

广东科斯达电器开关厂

DECIMALS:		ANGLES:		DWG NO.	PART NAME:
DIM	TOL	DIM	TOL	DESIGN:	PART NO.
X.	±0.50	X.	±2°	CHECK:	
X.X	±0.30	X.X	±1°	APPROVED	
X.XX	±0.20	X.XX	----	REV.	UNIT:
X.XXX	±0.10	X.XXX	----	A	mm
				SHEET:	1/1

②	HOUSING	1	LCP		BLACK
①	CONTACT A	2	PHOSPHOR BRONZE 0.20T	Au PLATED	
ITEM	PART NAME	Q'TY	MATERTAL	DESCRIPTION	REMARK