

REV.	ECN NO.	DESCRIPTION	DESIGN	DATE
A		INITIAL	Kai	2018.03.29

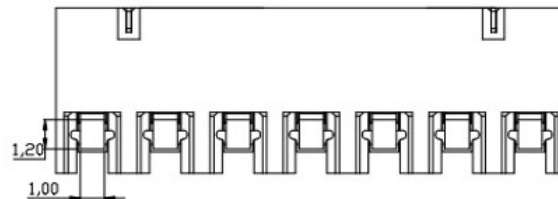
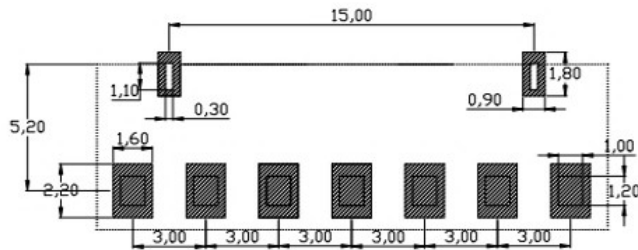
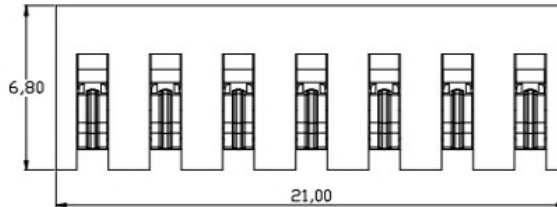
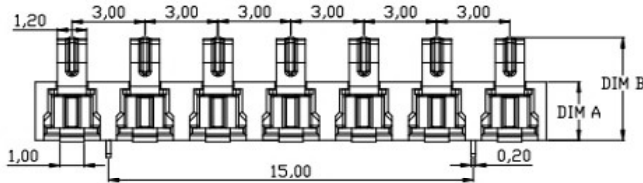
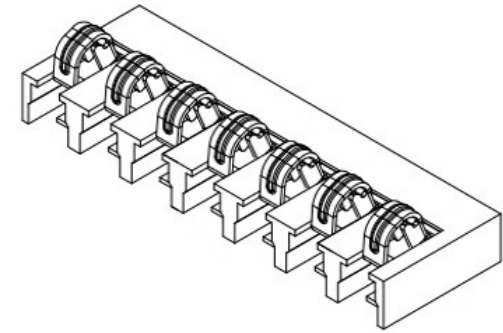
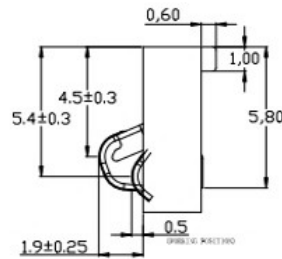
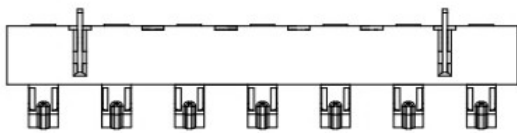

性能:
 额定电流: 3.0A
 额定电压: 24V
 耐电压: 500V
 接触电阻: 30mΩ MAX
 绝缘电阻: 500MΩ
 工作温度: -40℃~+85℃
 塑件(材质): LCP, 耐高温260℃
 接触点(材质): 铜合金, 触点镀金3U

RECOMMENDED PCB LAYOUT
 TOP VIEW (XX±0.05)

UNLESS OTHERWISE SPECIFIED TOLERANCES

广东科斯达电器开关厂

②	HOUSING	1	LCP		BLACK
①	CONTACT A	2	PHOSPHOR BRONZE 0.20T	Au PLATED	
ITEM	PART NAME	Q'TY	MATERTAL	DESCRIPTION	REMARK

DECIMALS:	ANGLES:	DWG NO.	PART NAME:
DIM TOL	DIM TOL	DESIGN:	PART NO.
X. ±0.50	X. ±2°	CHECK:	REV. UNIT: SHEET:
X.X ±0.30	X.X ±1°	APPROVED	A mm 1/1
X.XX ±0.20	X.XX		
X.XXX ±0.10	X.XXX		