

REV.	ECN NO.	DESCRIPTION	DESIGN	DATE
A		INITIAL	Kai	2018.03.29

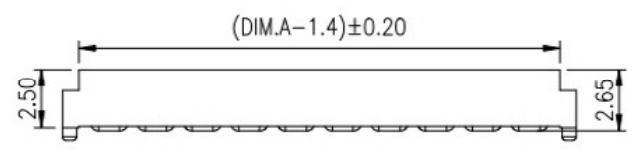

NOTE:  
Material  
Insulator:Nylon 9T(UL94V-0)  
Contact:phosphor Bronze  
Contact Plated:Gold over Nickel or Tin  
Specification  
Rated voltage: 12V 30V  
Current rating: 3A 5A  
instant CURRENT:7A  
Contact Resistance:30MΩ  
Insulation Resistance:100MΩ  
Dielectric Voltage:1000V  
Operdting Temperature:-40°~105°

PIN	Dim.A	Dim.B	Dim.C
02pin	6.00	2.00	5.40
03pin	8.00	4.00	7.40
04pin	10.00	6.00	9.40
05pin	12.00	8.00	11.40
06pin	14.00	10.00	13.40
07pin	16.00	12.00	15.40
08pin	18.00	14.00	17.40
09pin	20.00	16.00	19.40
10pin	22.00	18.00	21.40

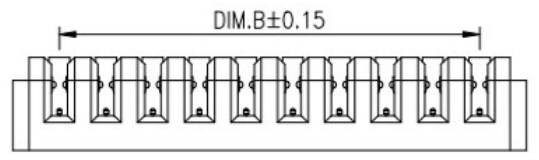
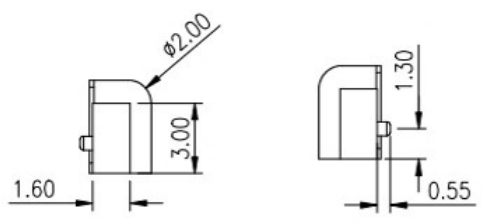
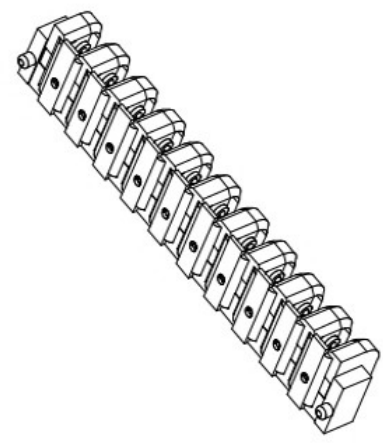
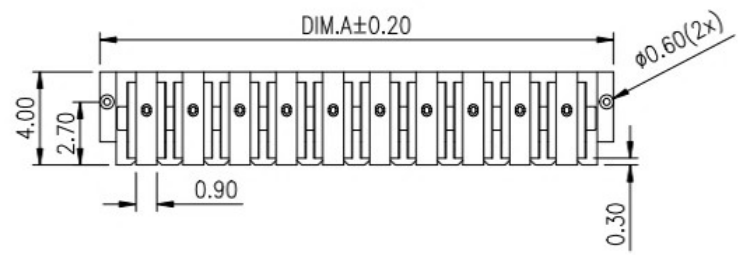
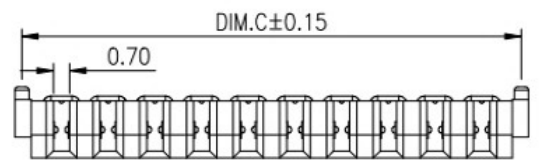
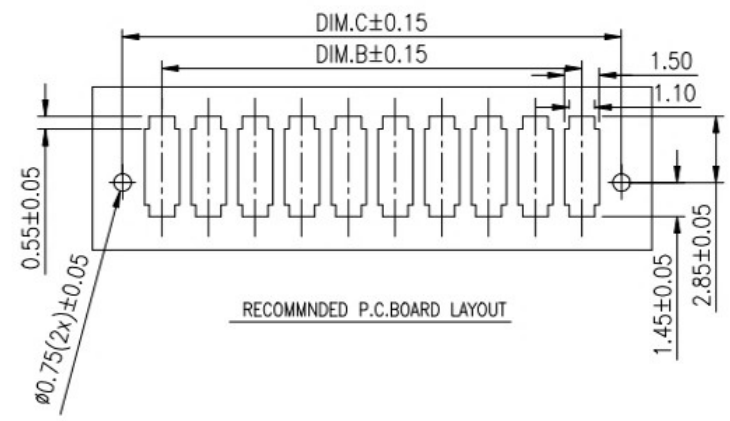

UNLESS OTHERWISE SPECIFIED TOLERANCES				<b>广东科斯达电器开关厂</b>			
DECIMALS:		ANGLES:		DWG NO.	PART NAME:		
DIM	TOL	DIM	TOL	DESIGN:	PART NO.		
X.	±0.50	X.	±2°	CHECK:	REV. UNIT: SHEET:		
X.X	±0.30	X.X	±1°	APPROVED	A	mm	1/1
X.XX	±0.20	X.XX	---				
X.XXX	±0.10	X.XXX	---				

ITEM	PART NAME	Q'TY	MATERTAL	DESCRIPTION	REMARK
②	HOUSING	1	LCP		BLACK
①	CONTACT A	2	PHOSPHOR BRONZE 0.20T	Au PLATED	

REV.	ECN NO.	DESCRIPTION	DESIGN	DATE
A		INITIAL	Kai	2018.03.29

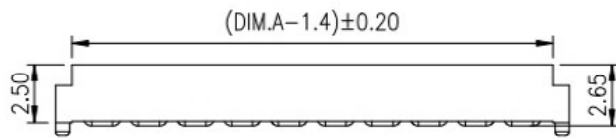
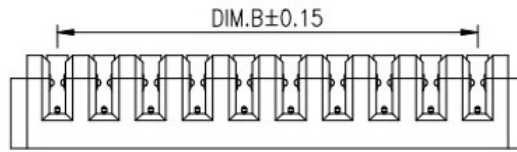
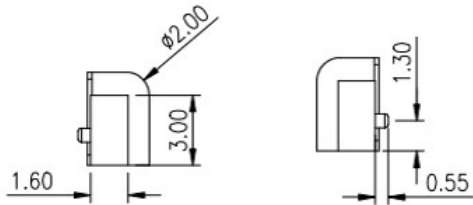
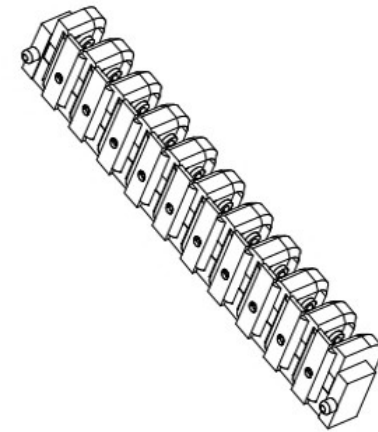
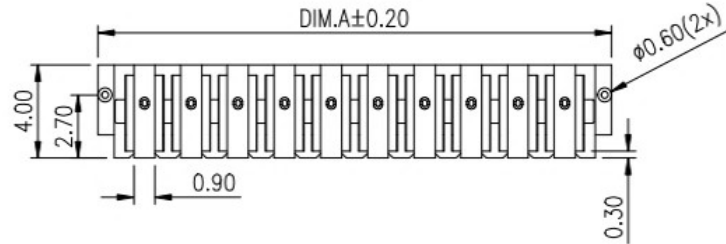
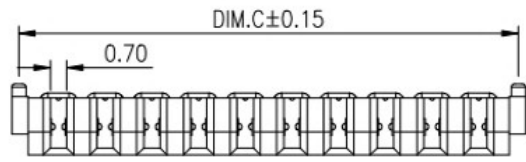

PIN	Dim.A	Dim.B	Dim.C
02pin	6.00	2.00	5.40
03pin	8.00	4.00	7.40
04pin	10.00	6.00	9.40
05pin	12.00	8.00	11.40
06pin	14.00	10.00	13.40
07pin	16.00	12.00	15.40
08pin	18.00	14.00	17.40
09pin	20.00	16.00	19.40
10pin	22.00	18.00	21.40

NOTE:  
 Material  
 Insulator:Nylon 9T(UL94V-0)  
 Contact:phosphor Bronze  
 Contact Plated:Gold over Nickel or Tin  
 Specification  
 Rated voltage: 12V 30V  
 Current rating: 3A 5A  
 instant CURRENT:7A  
 Contact Resistance:30MΩ  
 Insulation Resistance:100MΩ  
 Dielectric Voltage:1000V  
 Operdting Temperature:-40°~105°

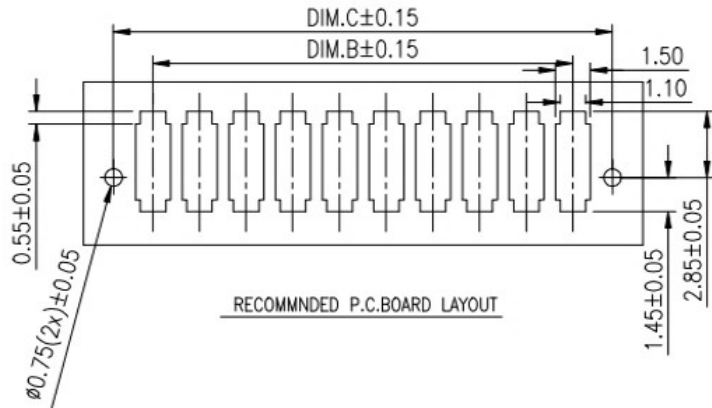

UNLESS OTHERWISE SPECIFIED TOLERANCES

广东科斯达电器开关厂

DECIMALS:		ANGLES:		DWG NO.	PART NAME:
DIM	TOL	DIM	TOL	DESIGN:	PART NO.
X.	±0.50	X.	±2°	CHECK:	REV. A
X.X	±0.30	X.X	±1°	APPROVED	UNIT: mm
X.XX	±0.20	X.XX	----		SHEET: 1/1
X.XXX	±0.10	X.XXX	----		

ITEM	PART NAME	Q'TY	MATERTAL	DESCRIPTION	REMARK
②	HOUSING	1	LCP		BLACK
①	CONTACT A	2	PHOSPHOR BRONZE 0.20T	Au PLATED	