

REV.	ECN NO.	DESCRIPTION	DESIGN	DATE
A		INITIAL	Kai	2018.03.29

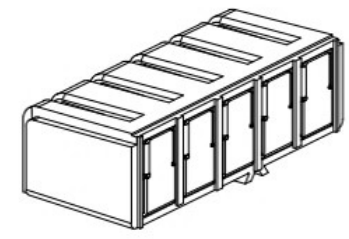

PIN	Dim.A	Dim.B	Dim.C
02pin	10.70	10.20	5.00
03pin	15.70	15.20	10.00
04pin	20.70	20.20	15.00
05pin	25.70	25.20	20.00

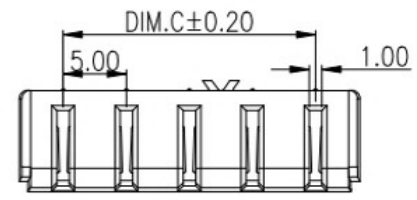
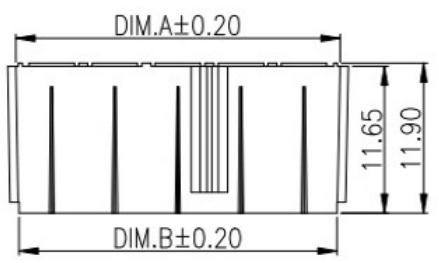
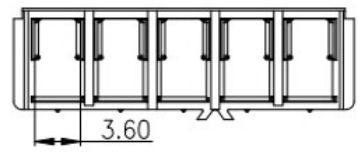
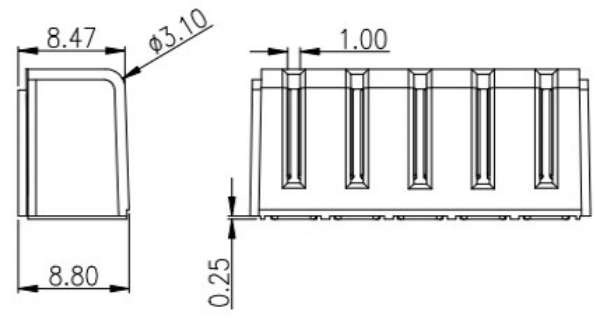

NOTE:
 Material
 Insulator:Nylon 9T(UL94V-0)
 Contact:phosphor Bronze
 Contact Plated:Gold over Nickel or Tin
 Specification
 Rated voltage: 12V 30V
 Current rating: 3A 5A
 instant CURRENT:7A
 Contact Resistance:30MΩ
 Insulation Resistance:100MΩ
 Dielectric Voltage:1000V
 Operdting Temperature:-40°~105°

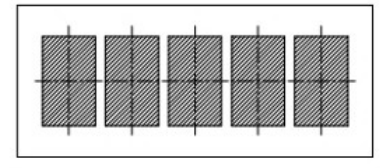
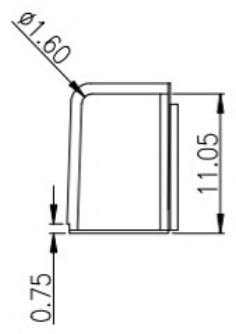

RECOMMENDED P.C.BOARD LAYOUT

UNLESS OTHERWISE SPECIFIED TOLERANCES				广东科斯达电器开关厂			
DECIMALS:		ANGLES:		DWG NO.	PART NAME:		
DIM	TOL	DIM	TOL	DESIGN:	PART NO.		
X.	±0.50	X.	±2°	CHECK:	REV. UNIT: SHEET:		
X.X	±0.30	X.X	±1°	APPROVED	A	mm	1/1
X.XX	±0.20	X.XX	---				
X.XXX	±0.10	X.XXX	---				

ITEM	PART NAME	Q'TY	MATERTAL	DESCRIPTION	REMARK
②	HOUSING	1	LCP		BLACK
①	CONTACT A	2	PHOSPHOR BRONZE 0.20T	Au PLATED	