

REV.	ECN NO.	DESCRIPTION	DESIGN	DATE
A		INITIAL	Kai	2018.03.29

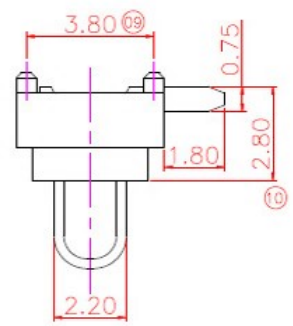
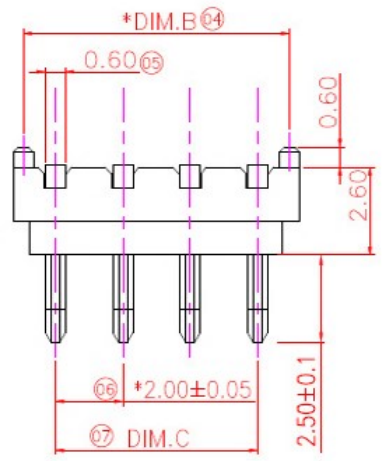
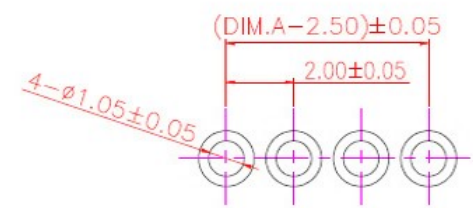
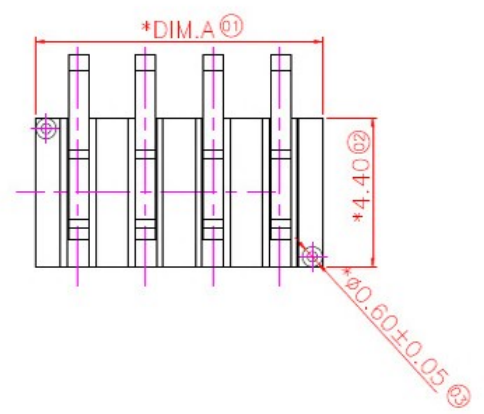

TABLE:

Pin/NO.	DIM.A	DIM.B	DIM.C
2Pin	4.50	3.90	2.00
3Pin	6.50	5.90	4.00
4Pin	8.50	7.90	6.00
5Pin	10.50	9.90	8.00
6Pin	12.50	11.90	10.00
7Pin	14.50	13.90	12.00
8Pin	16.50	15.90	14.00



Recommended P.C.Board Layout

NOTE:

Material  
 Insulator:Nylon 9T(UL94V-0)  
 Contact:phosphor Bronze  
 Contact Plated:Gold over Nickel or Tin  
 Specification  
 Rated voltage: 12V 30V  
 Current rating: 3A 5A  
 instant CURRENT:7A  
 Contact Resistance:30MΩ  
 Insulation Resistance:100MΩ  
 Dielectric Voltage:1000V  
 Operdting Temperature:-40°~105°

UNLESS OTHERWISE SPECIFIED TOLERANCES				<b>广东科斯达电器开关厂</b>			
DECIMALS:		ANGLES:		DWG NO.	PART NAME:		
DIM	TOL	DIM	TOL	DESIGN:	PART NO.		
X.	±0.50	X.	±2°	CHECK:	REV. UNIT: SHEET:		
X.X	±0.30	X.X	±1°	APPROVED	A	mm	1/1
X.XX	±0.20	X.XX	----				
X.XXX	±0.10	X.XXX	----				

ITEM	PART NAME	Q'TY	MATERTAL	DESCRIPTION	REMARK
②	HOUSING	1	LCP		BLACK
①	CONTACT A	2	PHOSPHOR BRONZE 0.20T	Au PLATED	

REV.	ECN NO.	DESCRIPTION	DESIGN	DATE
A		INITIAL	Kai	2018.03.29

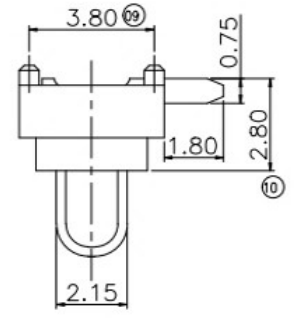
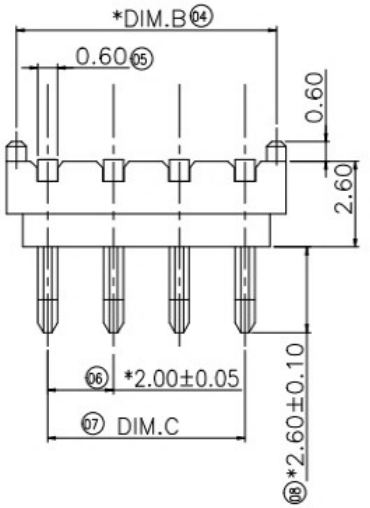

DIM.A	DIM.B	DIM.C
6.50	5.90	4.00
8.50	7.90	6.00
10.50	9.90	8.00
12.50	11.90	10.00
14.50	13.90	12.00
16.50	15.90	14.00
18.50	17.90	16.00
20.50	19.90	18.00

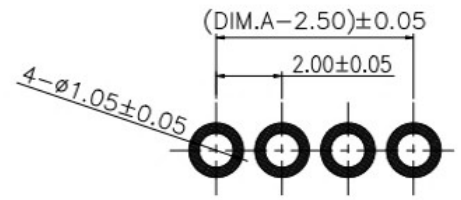
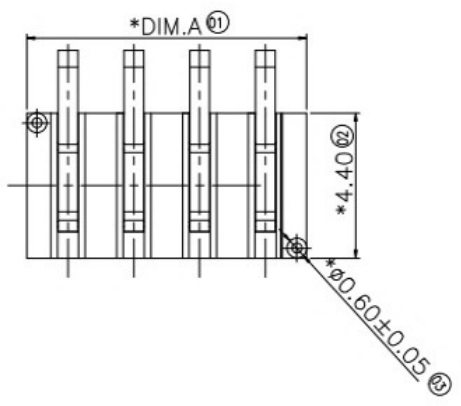

Recommended P.C.Board Layout

NOTE:  
 Material  
 Insulator: Nylon 9T(UL94V-0)  
 Contact: phosphor Bronze  
 Contact Plated: Gold over Nickel or Tin  
 Specification  
 Rated voltage: 12V 30V  
 Current rating: 3A 5A  
 instant CURRENT: 7A  
 Contact Resistance: 30MΩ  
 Insulation Resistance: 100MΩ  
 Dielectric Voltage: 1000V  
 Operating Temperature: -40°~105°

UNLESS OTHERWISE SPECIFIED TOLERANCES				<b>广东科斯达电器开关厂</b>			
DECIMALS:		ANGLES:		DWG NO.	PART NAME:		
DIM	TOL	DIM	TOL	DESIGN:	PART NO.		
X.	±0.50	X.	±2°	CHECK:	REV. UNIT: SHEET:		
X.X	±0.30	X.X	±1°	APPROVED	A	mm	1/1
X.XX	±0.20	X.XX	---				
X.XXX	±0.10	X.XXX	---				

ITEM	PART NAME	Q'TY	MATERIAL	DESCRIPTION	REMARK
②	HOUSING	1	LCP		BLACK
①	CONTACT A	2	PHOSPHOR BRONZE 0.20T	Au PLATED	