

REV.	ECN NO.	DESCRIPTION	DESIGN	DATE
A		INITIAL	Kai	2018.03.29

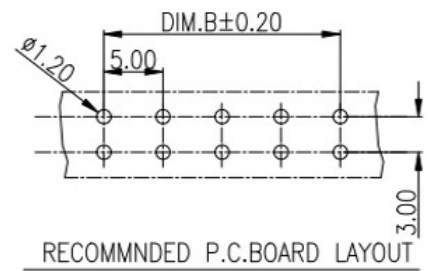
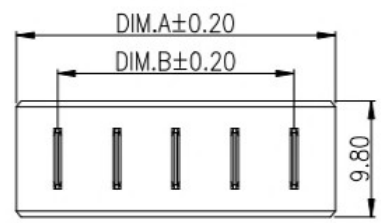
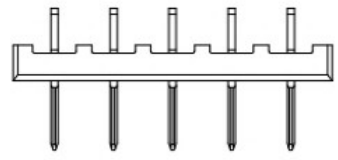
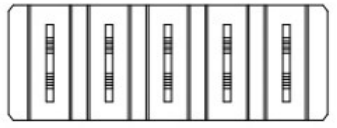
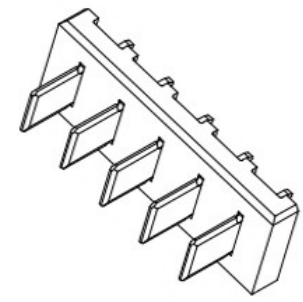
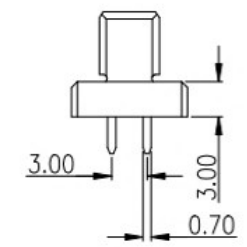
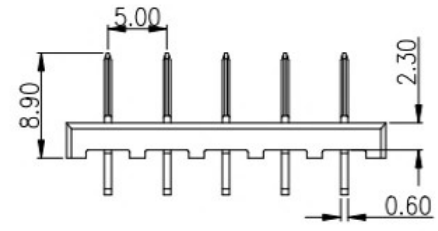
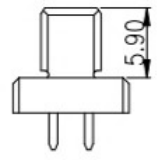

NOTE:  
 Material  
 Insulator:Nylon 9T(UL94V-0)  
 Contact:phosphor Bronze  
 Contact Plated:Gold over Nickel or Tin  
 Specification  
 Rated voltage: 12V 30V  
 Current rating: 3A 5A  
 instant CURRENT:7A  
 Contact Resistance:30MΩ  
 Insulation Resistance:100MΩ  
 Dielectric Voltage:1000V  
 Operdting Temperature:-40°~105°

PIN	Dim.A	Dim.B
02pin	12.00	5.00
03pin	17.00	10.00
04pin	22.00	15.00
05pin	27.00	20.00

UNLESS OTHERWISE SPECIFIED TOLERANCES				广东科斯达电器开关厂			
DECIMALS:		ANGLES:					
DIM	TOL	DIM	TOL	DESIGN:	PART NO.		
X.	±0.50	X.	±2°	CHECK:	REV. UNIT: SHEET:		
X.X	±0.30	X.X	±1°	APPROVED	A	mm 1/1	
X.XX	±0.20	X.XX	----				
X.XXX	±0.10	X.XXX	----				

ITEM	PART NAME	Q'TY	MATERTAL	DESCRIPTION	REMARK
②	HOUSING	1	LCP		BLACK
①	CONTACT A	2	PHOSPHOR BRONZE 0.20T	Au PLATED	