

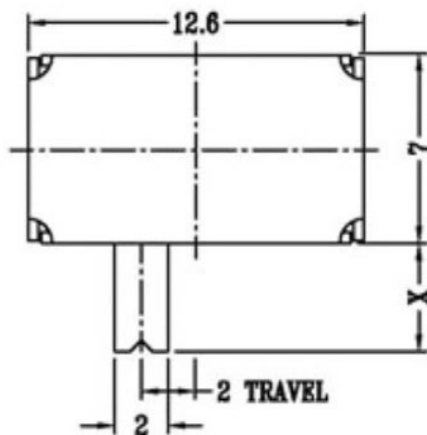

CAD FILE:

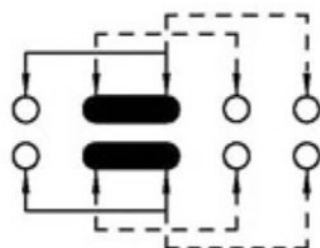

X=2-8
单位: mm

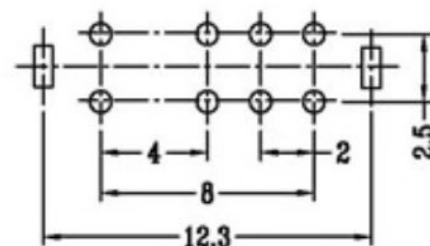
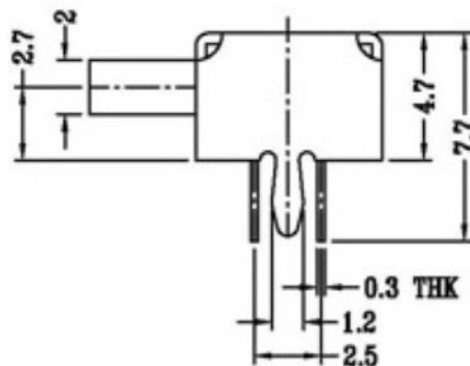
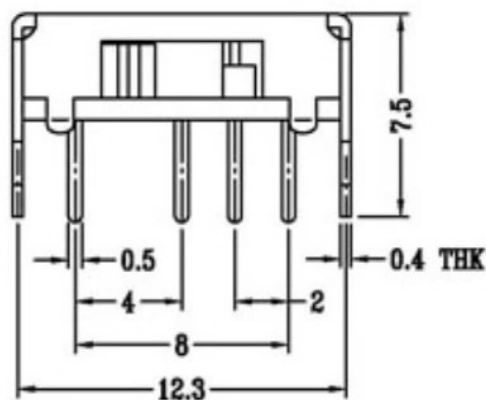

SCHEMATIC (SHORTING)

P.C.B LAYOUT
BOTTOM VIEW

注: "*"表示关键尺寸(6个)

NO.	PARTS	MATERIALS	QTY	FINISH	TOLERANCE UNLESS SPECIFIED		A 2012-12-25		初板		
					WITHIN	ISSUE	DATE	DESCRIPTIONS OF REVISION			APPD
8					OVER						
7	STEEL BALL	STEEL	1	NATURAL	TITLE: HORIZONTAL SLIDE SWITCH		UNIT : mm	DRWG NO.:			
6	SPRING	STEEL WIRE	1	NATURAL	MODEL:		SCALE: 2:1	DWN		2012-12-25	
5	CONTACT CLIP	PBS STRIP	2	Ag PLATED	广东科斯达开关厂				CHK'D		
4	TERMINAL	BRASS STRIP	10	Ag PLATED			APPD		2012-12-25		
3	BASE	PHENOLIC RESIN	1	BLACK					APPD	2012-12-25	
2	FRAME	STEEL STRIP	1	Ni PLATED							
1	KNOB	POM	1	BLACK							