

按键帽A99

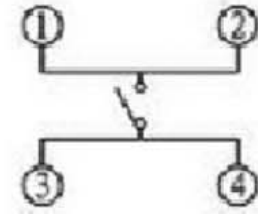
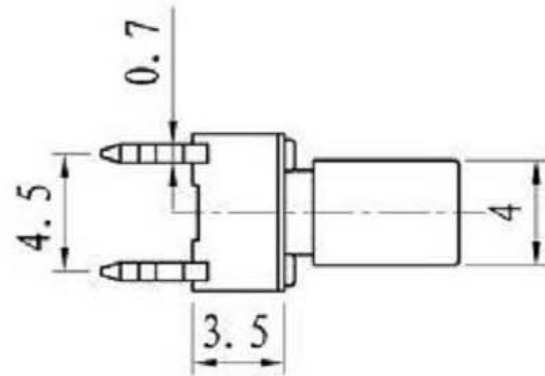
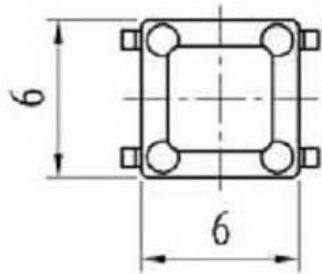
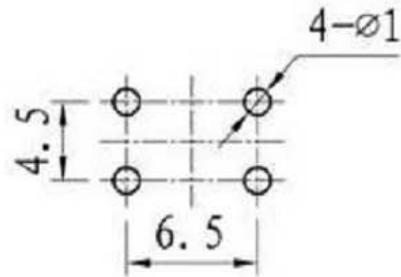
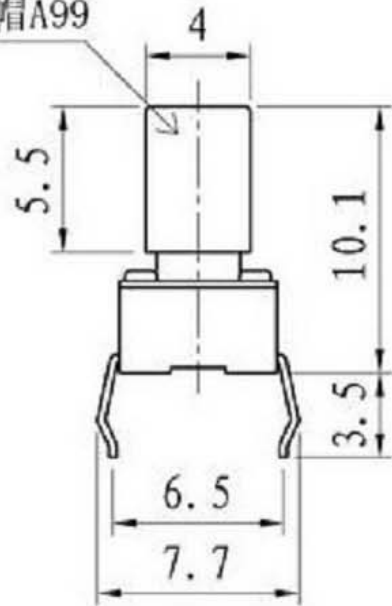

SCHEMATIC

SPECIFICATIONS

1. RATING : 0.5mA 12VDC MAX .
2. CONTACT RESISTANCE : 100 mΩ MAX .
3. INSULATION RESISTANCE : 500 V DC , 100 MΩ MIN
4. OPERATING TEMPERATURE : -20℃ ~ 70℃ .
5. OPERATING FORCE : 160±50gf . 250±50gf
6. OPERATING LIFE : 100,000 CYCLES .



广东科斯达开关厂

TITLE : TACTILE SWITCH

MODEL :

DRAWING NO. : -

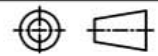

UNIT : M M	DWN.	LSX	2015-02-18	GENERAL TOLERANCE
SCALE : 5 : 1	CHK'D	LJ	2015-02-18	WITHIN 1.5mm±0.1mm
LEVEL 1	REV R1	APPD.	CC	2015-02-18
				OVER 1.5mm±0.2mm

9				
8				
7				
6	CAP	ABS/PC	1	SLIVER /BLACK
5	CONTACT	PBS	1	Ag CLAD
4	TERMINAL	BRASS STRIP	4	Ag PLATED
3	BASE	PA66	1	BLACK
2	COVER	PET	1	NATURAL
1	KNOB	PA66	1	WHITE
NO.	PART NAME	MATERIAL	QTY.	FINISHING