

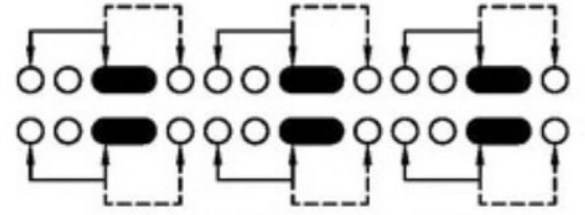

CAD FILE:

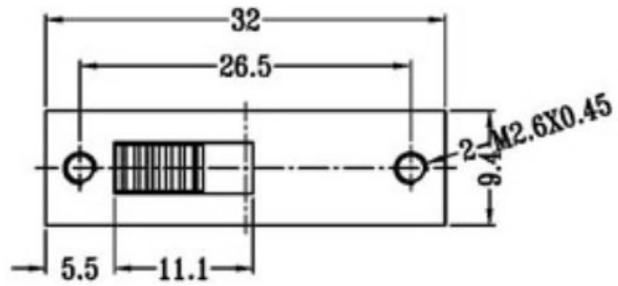

SCHEMATIC (NON-SHORTING)

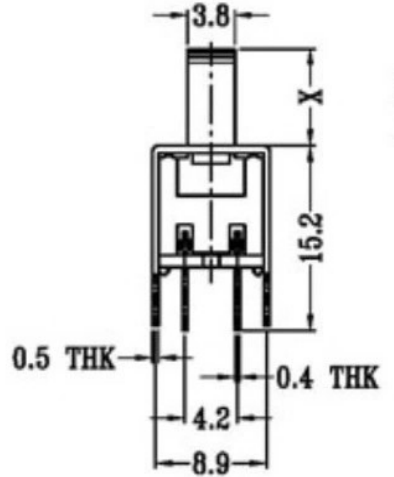
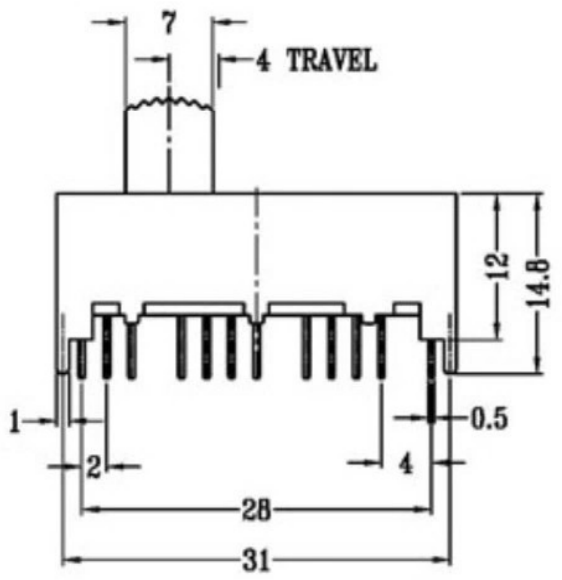

X=3-13
单位: mm

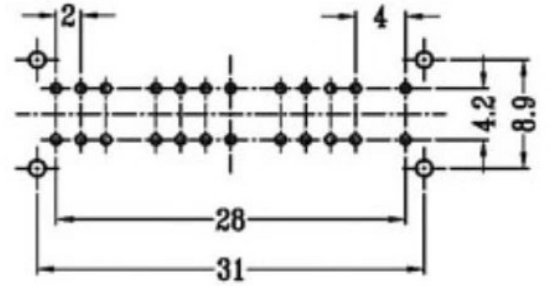

P.C.B LAYOUT
BOTTOM VIEW

注: "*"表示关键尺寸(6个)

8				
7	STEEL BALL	STEEL	1	NATURAL
6	SPRING	STEEL WIRE	1	NATURAL
5	CONTACT CLIP	PBS STRIP	2	Ag PLATED
4	TERMINAL	BRASS STRIP	8	Ag PLATED
3	BASE	PHENOLIC RESIN	1	NATURAL
2	FRAME	STEEL STRIP	1	Ni PLATED
1	KNOB	POM	1	BLACK
NO.	PARTS	MATERIALS	Q'TY	FINISH

TOLERANCE UNLESS SPECIFIED				
WITHIN	A	2012-10-26	初版	
OVER	ISSUE	DATE	DESCRIPTIONS OF REVISION	
TITLE : VERTICAL SLIDE SWITCH		UNIT : mm	DRWG NO.:	
MODEL:		SCALE: 3:1	DWN.	2012-10-26
广东科斯达开关厂			CHK'D	
			APPD.	2012-10-26