

CAD FILE:

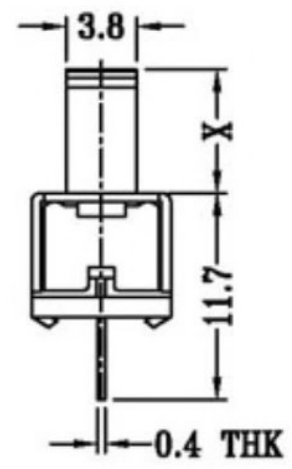
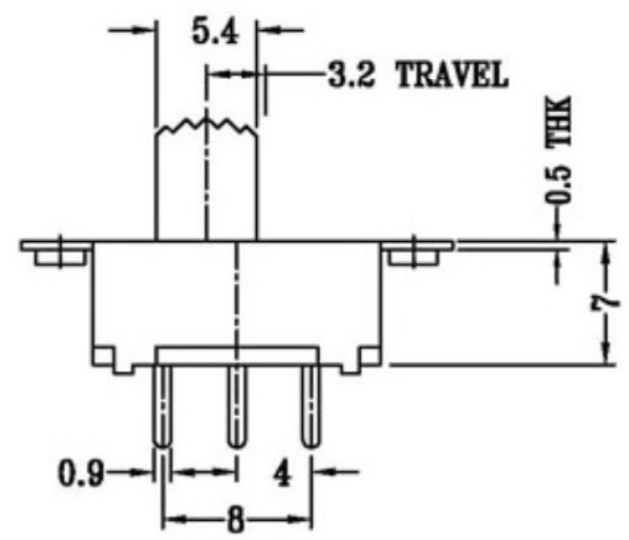
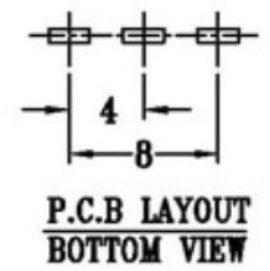
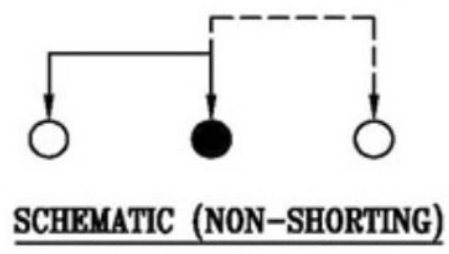
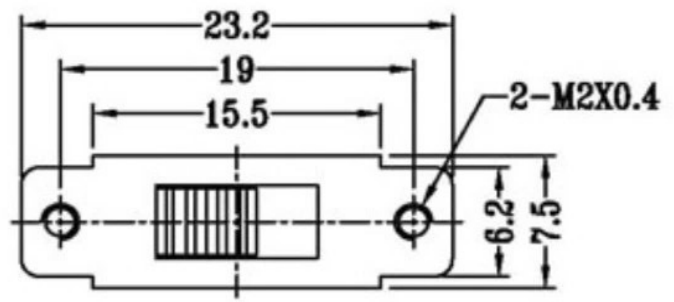

X=2-13
单位: mm

注: "*"表示关键尺寸(6个)

8					TOLERANCE						
7	STEEL BALL	STEEL	1	NATURAL	UNLESS SPECIFIED						
6	SPRING	STEEL WIRE	1	NATURAL	WITHIN	A	2012-10-26	初版			
5	CONTACT CLIP	PBS STRIP	2	Ag PLATED	OVER	ISSUE	DATE	DESCRIPTIONS OF REVISION			
4	TERMINAL	BRASS STRIP	8	Ag PLATED	TITLE : VERTICAL SLIDE SWITCH			UNIT : mm	DRWG NO.:		
3	BASE	PHENOLIC RESIN	1	NATURAL	MODEL:			SCALE: 3:1	DWN.	2012-10-26	
2	FRAME	STEEL STRIP	1	Ni PLATED	广东科斯达开关厂					CHK'D	
1	KNOB	POM	1	BLACK						APPD.	
NO.	PARTS	MATERIALS	Q'TY	FINISH							