

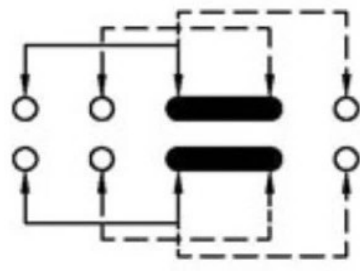

CAD FILE:

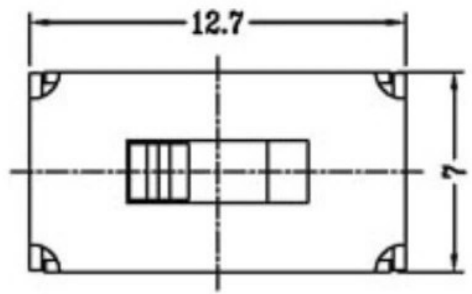

SCHEMATIC (SHORTING)

X=2-10
单位: mm

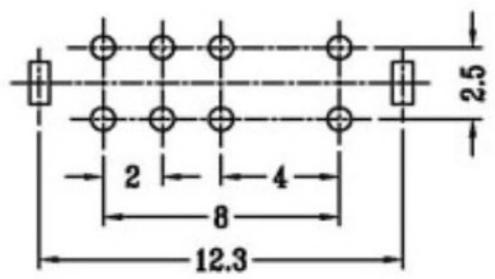
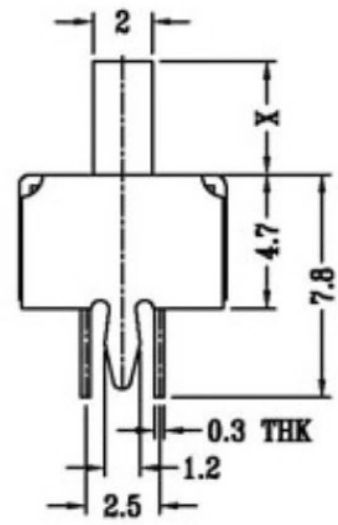
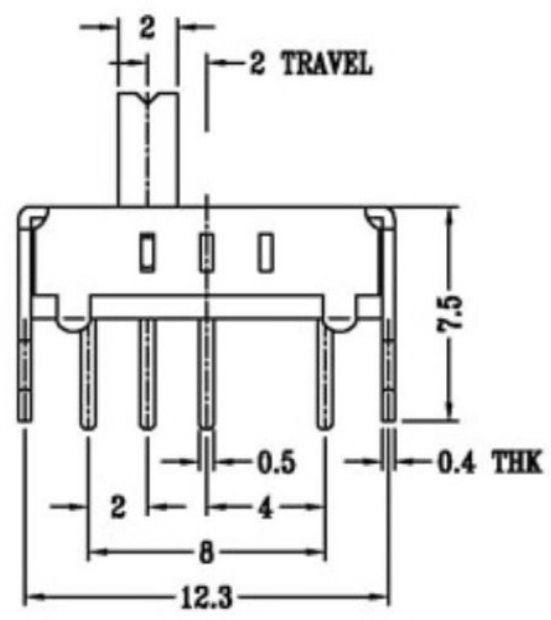

P.C.B LAYOUT
BOTTOM VIEW

注: "*"表示关键尺寸(6个)

8					TOLERANCE				
7	STEEL BALL	STEEL	1	NATURAL	UNLESS SPECIFIED				
6	SPRING	STEEL WIRE	1	NATURAL	WITHIN	A	2012-10-26	初版	
5	CONTACT CLIP	PBS STRIP	2	Ag PLATED	OVER	ISSUE	DATE	DESCRIPTIONS OF REVISION	APPD.
4	TERMINAL	BRASS STRIP	8	Ag PLATED	TITLE : VERTICAL SLIDE SWITCH			UNIT : mm	DRWG NO.:
3	BASE	PHENOLIC RESIN	1	NATURAL	MODEL:			SCALE: 3:1	DWN.
2	FRAME	STEEL STRIP	1	Ni PLATED	广东科斯达开关厂				2012-10-26
1	KNOB	POM	1	BLACK					CHK'D
NO.	PARTS	MATERIALS	Q'TY	FINISH					APPD.