

F E D C B A

ZONE	SYMBOL	REVISION	APPROVAL	DATE

RoHS  
Compliant

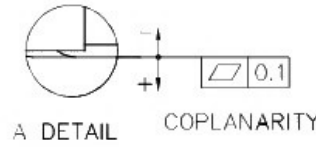
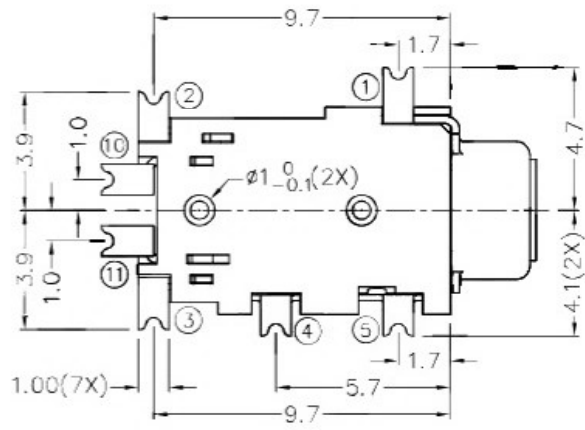
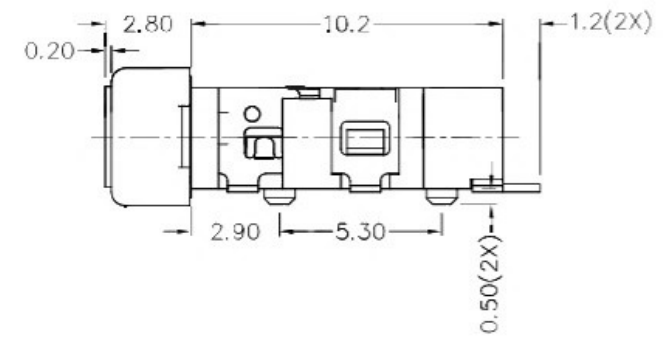
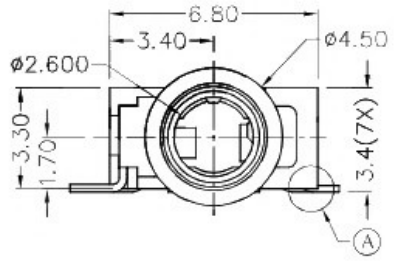
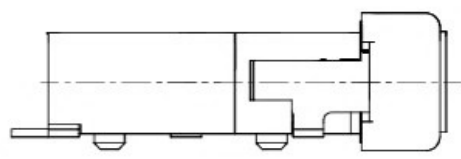
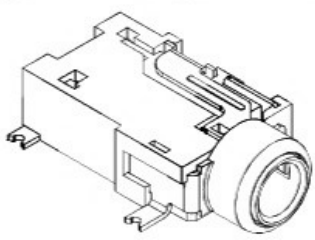

\* MATERIAL  
 TERMINAL 1 : BRASS  
 TERMINAL 2 : COPPER ALLOY  
 TERMINAL 3 : COPPER ALLOY  
 TERMINAL 4 : COPPER ALLOY  
 TERMINAL 5 : COPPER ALLOY  
 TERMINAL 10: BRASS  
 TERMINAL 11: BRASS  
 HOUSING : HIGH TEMP. PLASTIC

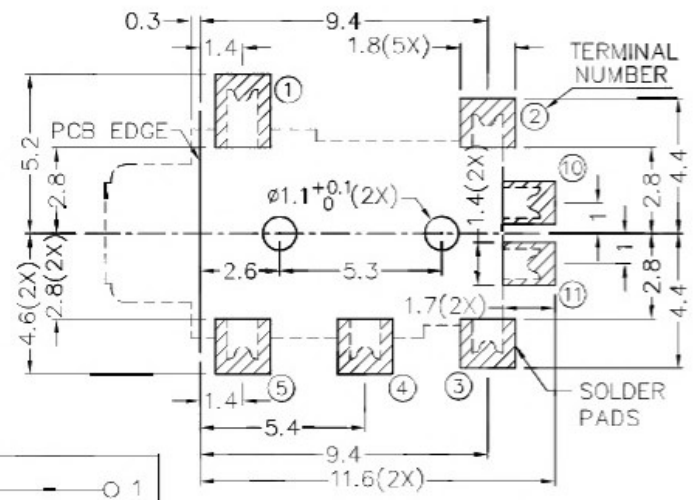

RECOMMENDED PCB LAYOUT  
 TOLERANCE: ±0.05  
 (TOP VIEW)

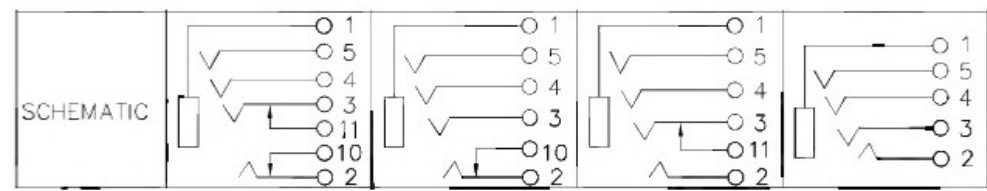
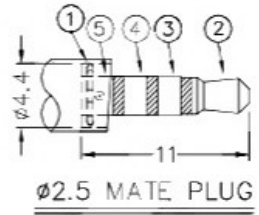

**广东科斯达开关厂**

DESIGN	J.X.KUANG	DATE	15-7-2004	SCALE	4:1
DRAWING	Y.J.GUO	DATE	7-3-2017	MATERIAL	*
CHECK	T.Y.LI	DATE	7-3-2017	DWG. NO.	TZ\TG288D-A/1.0
APPROVAL		DATE		SHEET	

PART NAME	2.5mm SMD STEREO JACK	TOLERANCE UNLESS	0.0±0.2	UNIT:	mm
PART NO.		OTHERWISE SPECIFIED:	0.00±0.1 0.000±0.05		

F E D C B A