

F

E

D

C

B

A

RoHS
Compliant

ZONE	SYMBOL	REVISION	APPROVAL	DATE

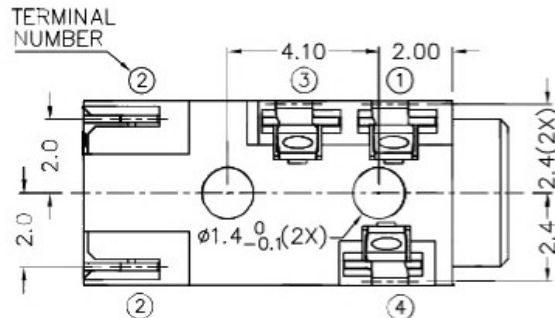
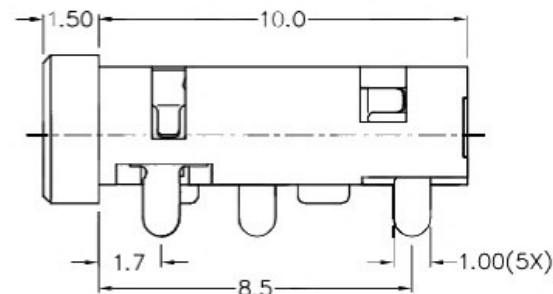
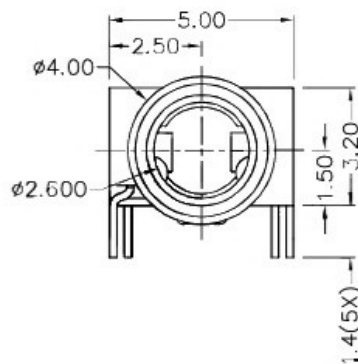
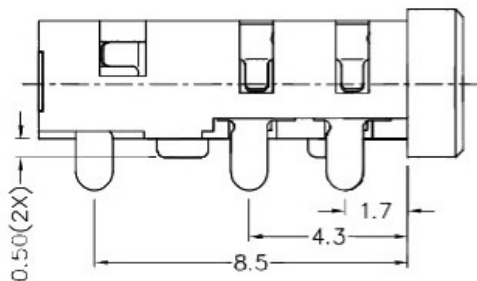
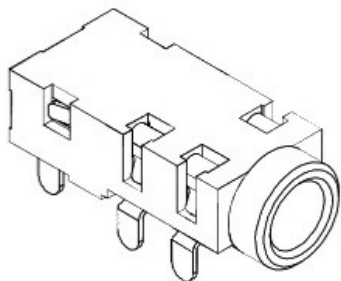

* MATERIAL

TERMINAL 1 : COPPER ALLOY
 TERMINAL 2 : COPPER ALLOY
 TERMINAL 3 : COPPER ALLOY
 TERMINAL 4 : COPPER ALLOY
 HOUSING : HIGH TEMP. PLASTIC

MODEL NO.	SCHEMATIC

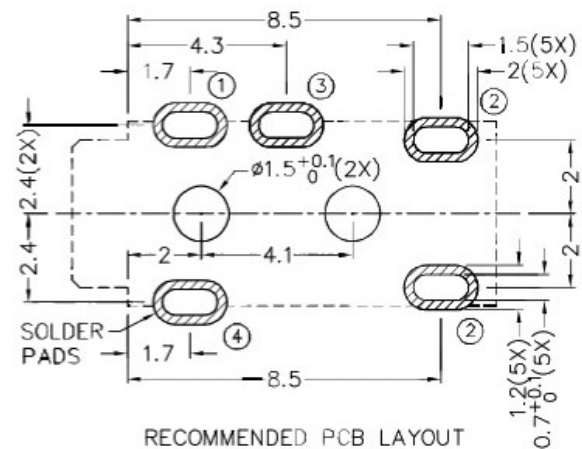

RECOMMENDED PCB LAYOUT
 TOLERANCE: ± 0.05
 (TOP VIEW)

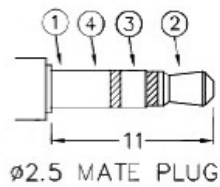

广东科斯达开关厂

DESIGN	H.L.TAN	DATE	7-12-2013	SCALE	5:1
DRAWING	J.CH.OU	DATE	23-9-2016	MATERIAL	*
CHECK	T.Y.LI	DATE	23-9-2016	DWG. NO.	TZ\TG285-A/1.0
APPROVAL		DATE	23-9-2016	SHEET	
PART NAME	2.5mm STEREO JACK		TOLERANCE UNLESS	0.0 \pm 0.2	UNIT:
PART NO.			OTHERWISE SPECIFIED:	0.00 \pm 0.1 0.000 \pm 0.05	

F

E

D

C

B

A