

F

E

D

C

B

A

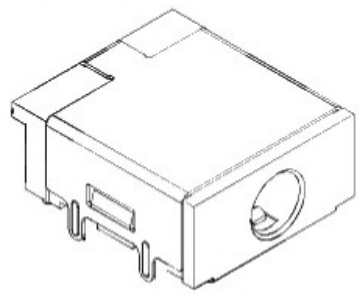

RoHS
Compliant

ZONE	SYMBOL	REVISION	APPROVAL	DATE

1

1

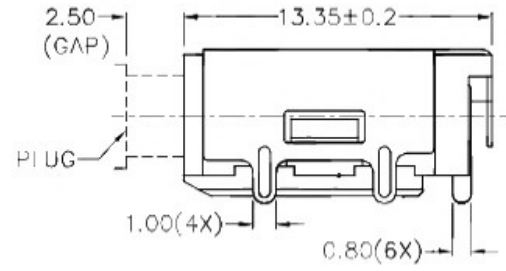
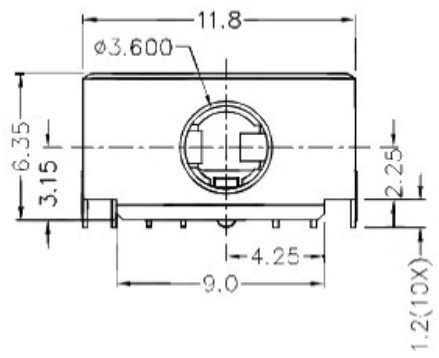
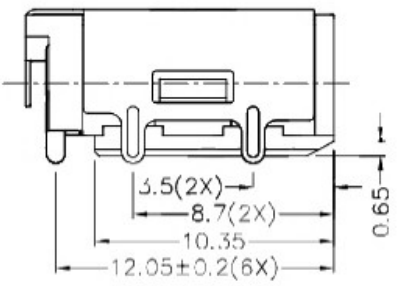

2

2

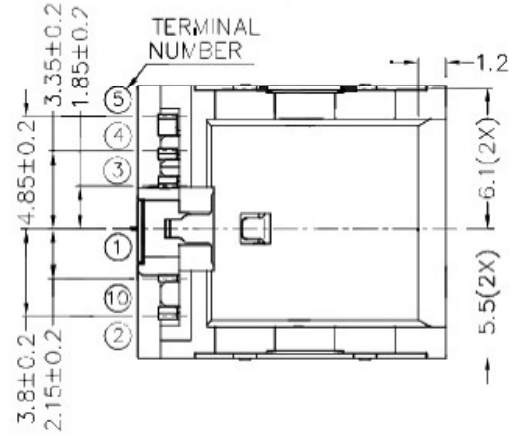

* MATERIAL

TERMINAL 1 : COPPER ALLOY
 TERMINAL 2 : COPPER ALLOY
 TERMINAL 3 : COPPER ALLOY
 TERMINAL 4 : COPPER ALLOY
 TERMINAL 5 : COPPER ALLOY
 TERMINAL 10 : BRASS
 SHIELD : BRASS
 HOUSING : HIGH TEMP. PLASTIC

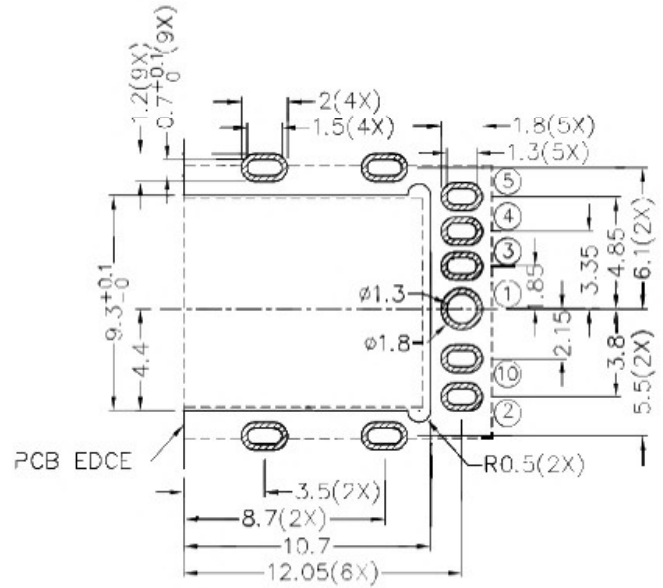

3

3

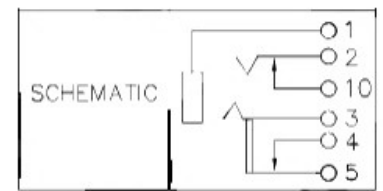
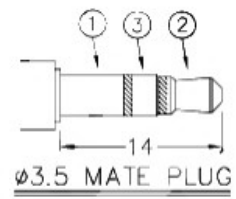

4

4

广东科斯达开关厂

DESIGN	CH.XIONG	DATE	20-7-2012	SCALE	3:1
DRAWING	J.CH.OU	DATE	19-1-2017	MATERIAL	*
CHECK	T.Y.LI	DATE	19-1-2017	DWG. NO.	TZ\SH551DS-2-A/1.0
APPROVAL		DATE		SHEET	

PART NAME	3.5mm SMD STEREO JACK	TOLERANCE UNLESS	0.0±0.2	UNIT:	mm
PART NO.		OTHERWISE SPECIFIED:	0.00±0.1 0.000±0.05		

F

E

D

C

B

A