

F

E

D

C

B

A

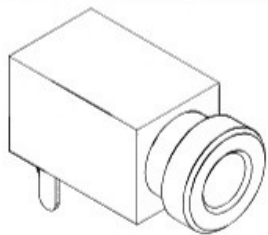

RoHS  
Compliant

ZONE	SYMBOL	REVISION	APPROVAL	DATE

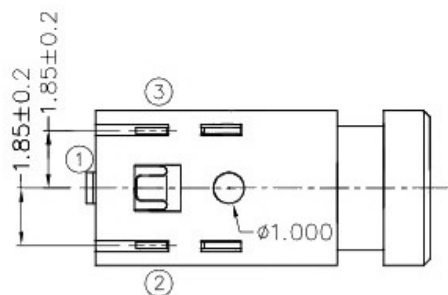
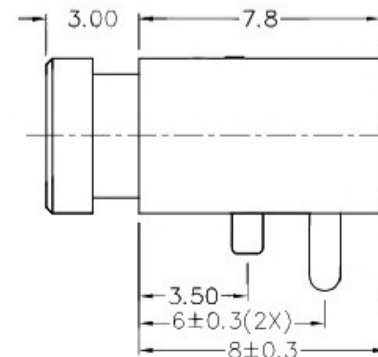
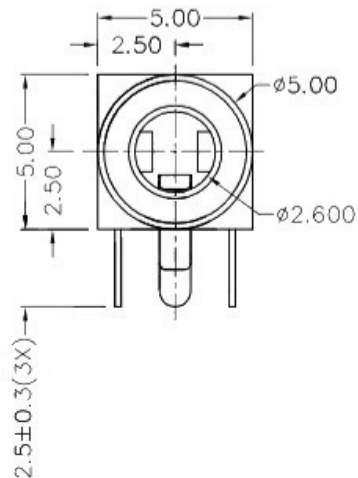
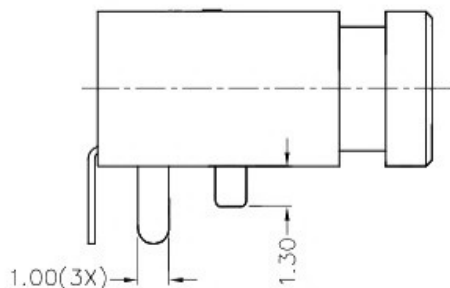

\* MATERIAL

TERMINAL 1 : COPPER ALLOY  
 TERMINAL 2 : COPPER ALLOY  
 TERMINAL 3 : COPPER ALLOY  
 BUSHING : BRASS  
 HOUSING : THERMOPLASTIC

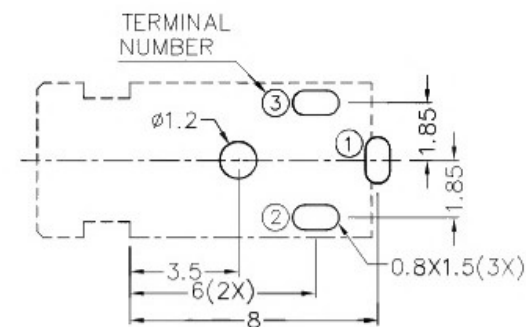

RECOMMENDED PCB LAYOUT  
 TOLERANCE:  $\pm 0.05$   
 (TOP VIEW)

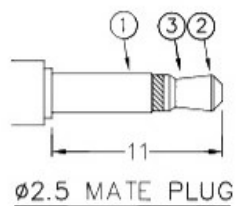
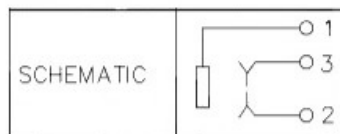

$\phi 2.5$  MATE PLUG

 广东科斯达开关厂

PART NAME	2.5mm PHONE JACK	TOLERANCE UNLESS	0.0 $\pm$ 0.2	UNIT:	mm
PART NO.		OTHERWISE SPECIFIED:	0.00 $\pm$ 0.1 0.000 $\pm$ 0.05		

DESIGN	T.Y.LI	DATE	15-6-2005	SCALE	4:1
DRAWING	H.Q.ZHOU	DATE	23-2-2017	MATERIAL	*
CHECK	H.L.TAN	DATE	23-2-2017	DWG. NO.	TZ\TG254-B/1.0
APPROVAL		DATE		SHEET	

F

E

D

C

B

A