

F

E

D

C

B

A

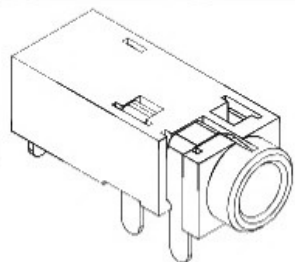

RoHS  
Compliant

ZONE	SYMBOL	REVISION	APPROVAL	DATE

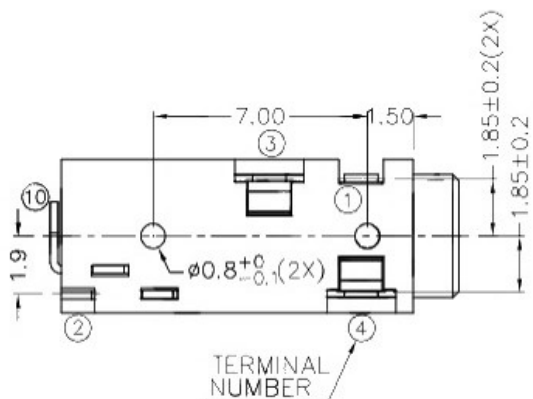
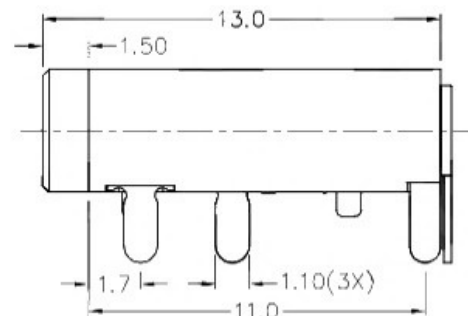
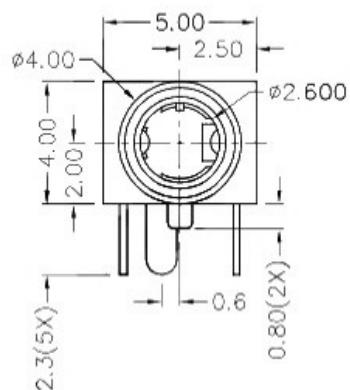
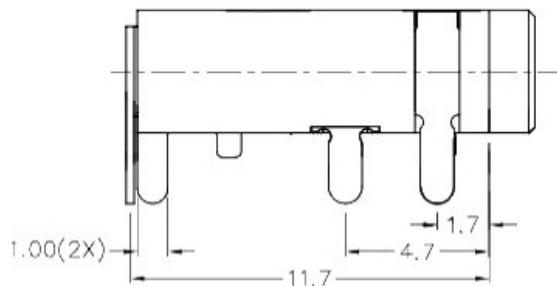

\* MATERIAL

TERMINAL 1 : COPPER ALLOY  
 TERMINAL 2 : COPPER ALLOY  
 TERMINAL 3 : COPPER ALLOY  
 TERMINAL 4 : COPPER ALLOY  
 TERMINAL 10: BRASS  
 HOUSING : THERMOPLASTIC

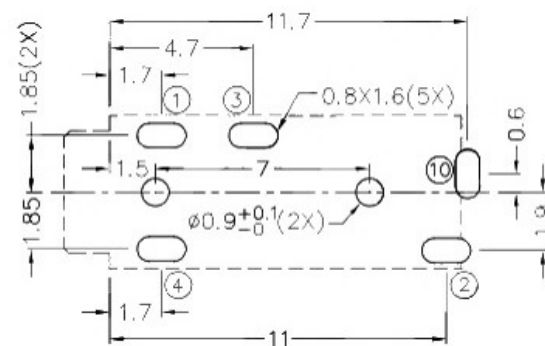

RECOMMENDED PCB LAYOUT  
 TOLERANCE: ±0.05  
 (TOP VIEW)

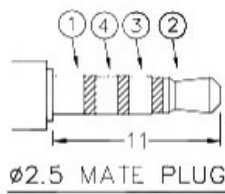

Ø2.5 MATE PLUG

SCHEMATIC

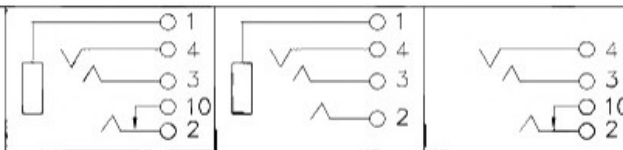

 广东科斯达开关厂

DESIGN	J.X.KUANG	DATE	13-12-2003	SCALE	4:1
DRAWING	H.Q.ZHOU	DATE	3-3-2017	MATERIAL	*
CHECK	T.Y.LI	DATE	3-3-2017	DWG. NO.	TZ\TG276-B/1.0
APPROVAL		DATE		SHEET	

PART NAME	2.5mm STEREO JACK	TOLERANCE UNLESS	0.0±0.2	UNIT:	mm
PART NO.		OTHERWISE SPECIFIED:	0.00±0.1 0.000±0.05		

F

E

D

C

B

A