

F

E

D

C

B

A

ZONE	SYMBOL	REVISION	APPROVAL	DATE

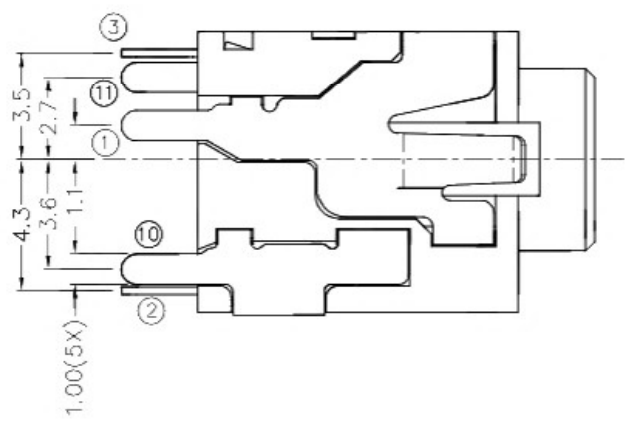
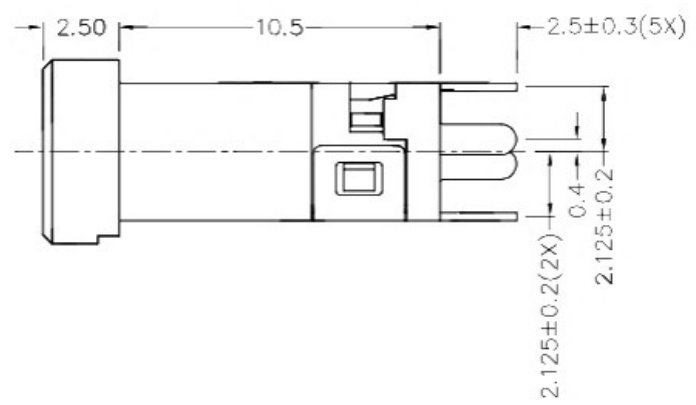
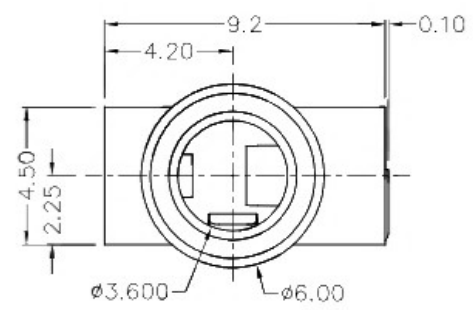
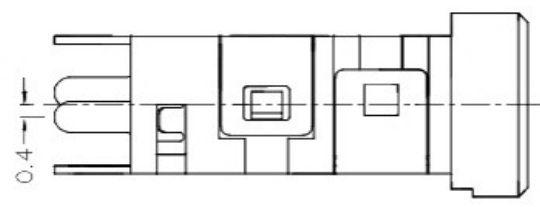
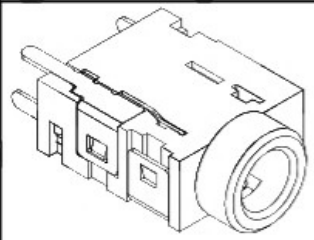

**\* MATERIAL**  
 TERMINAL 1 : COPPER ALLOY  
 TERMINAL 2 : COPPER ALLOY  
 TERMINAL 3 : COPPER ALLOY  
 TERMINAL 10: BRASS  
 TERMINAL 11: BRASS  
 HOUSING : THERMOPLASTIC

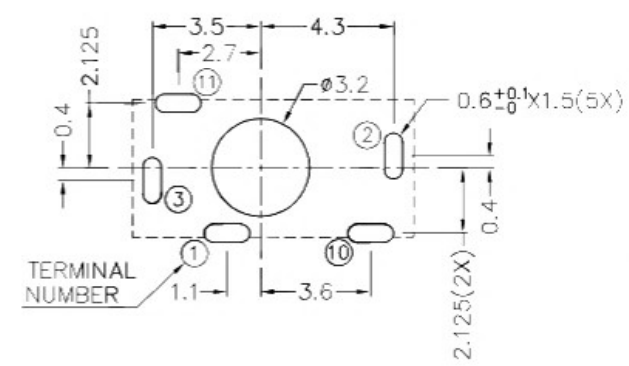

RECOMMENDED PCB LAYOUT  
 TOLERANCE:  $\pm 0.05$   
 (TOP VIEW)

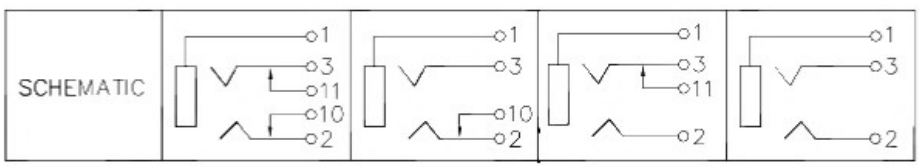
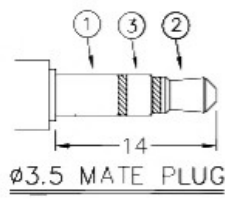

**RoHS**  
Compliant

**广东科斯达开关厂**

DESIGN	G.P.YI	DATE	16-8-2006	SCALE	4:1
DRAWING	H.Q.ZHOU	DATE	3-1-2017	MATERIAL	*
CHECK	T.Y.LI	DATE	3-1-2017	DWG. NO.	TZ\SH393-B/1.0
APPROVAL		DATE		SHEET	

PART NAME	3.5mm STEREO JACK	TOLERANCE UNLESS	0.0 $\pm$ 0.2	UNIT:	mm
PART NO.		OTHERWISE SPECIFIED:	0.00 $\pm$ 0.1 0.000 $\pm$ 0.05		

F

E

D

C

B

A