

F

E

D

C

B

A

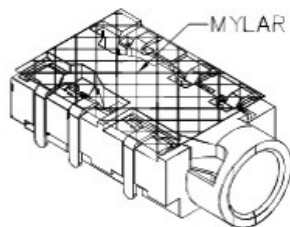

RoHS
Compliant

ZONE	SYMBOL	REVISION	APPROVAL	DATE

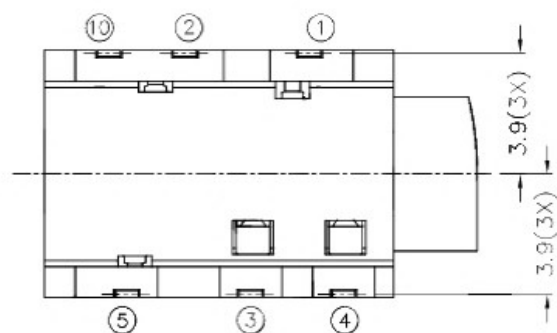
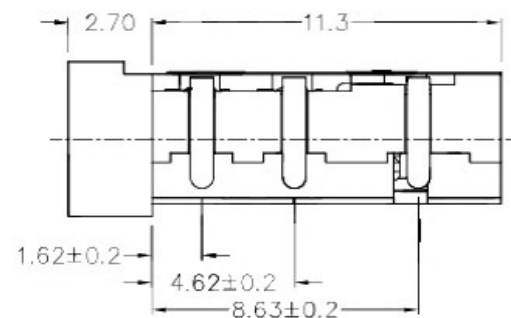
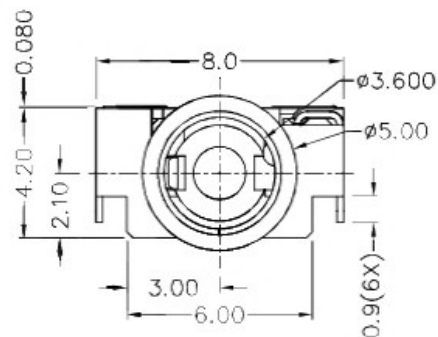
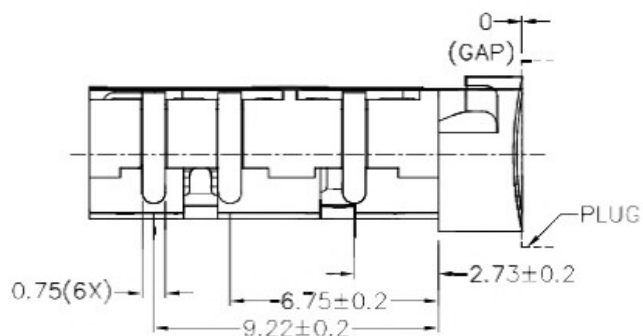

* MATERIAL

TERMINAL 1 : COPPER ALLOY
 TERMINAL 2 : COPPER ALLOY
 TERMINAL 3 : COPPER ALLOY
 TERMINAL 4 : COPPER ALLOY
 TERMINAL 5 : COPPER ALLOY
 TERMINAL 10: COPPER ALLOY
 MYLAR : POLYIMIDE
 HOUSING : HIGH TEMP. PLASTIC

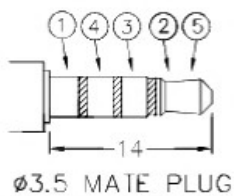
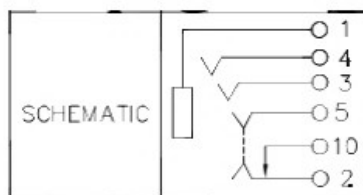
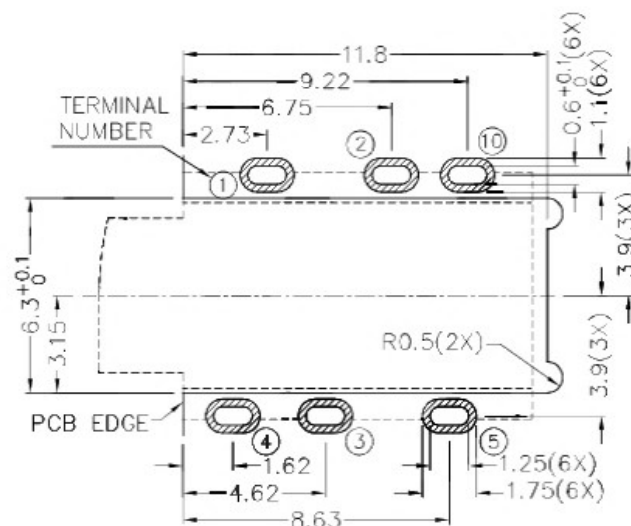

Ø3.5 MATE PLUG

RECOMMENDED PCB LAYOUT
 TOLERANCE: ±0.05
 (TOP VIEW)

广东科斯达开关厂

PART NAME	3.5mm SMD STEREO JACK	TOLERANCE UNLESS	0.0±0.2	UNIT:	mm
PART NO.		OTHERWISE SPECIFIED:	0.00±0.1 0.000±0.05		

DESIGN	H.L.TAN	DATE	18-5-2017	SCALE	4:1
DRAWING	H.Q.ZHOU	DATE	25-8-2017	MATERIAL	*
CHECK	T.Y.LI	DATE	25-8-2017	DWG. NO.	TZ\SH612DT1-A/1.0
APPROVAL		DATE		SHEET	

F

E

D

C

B

A