

| ZONE | SYMBOL | REVISION | APPROVAL | DATE |
|------|--------|----------|----------|------|
| | | | | |
| | | | | |
| | | | | |

RoHS
Compliant

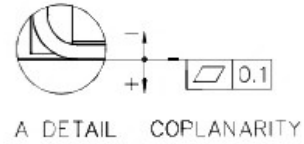

- * MATERIAL
- TERMINAL 1 : COPPER ALLOY
 - TERMINAL 2 : COPPER ALLOY
 - TERMINAL 3 : COPPER ALLOY
 - TERMINAL 4 : COPPER ALLOY
 - TERMINAL 5 : COPPER ALLOY
 - TERMINAL 10: BRASS
 - TERMINAL 11: BRASS
 - HOUSING : HIGH TEMP. PLASTIC

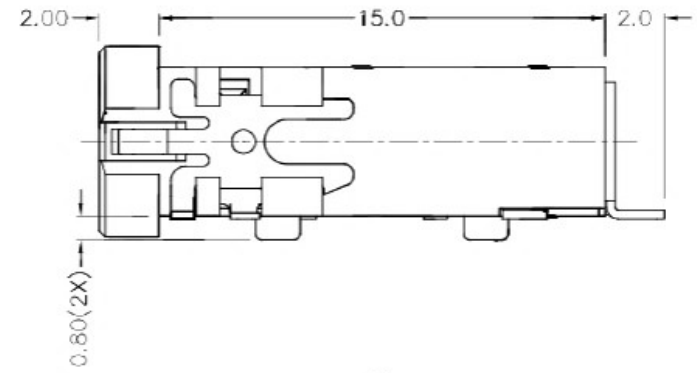
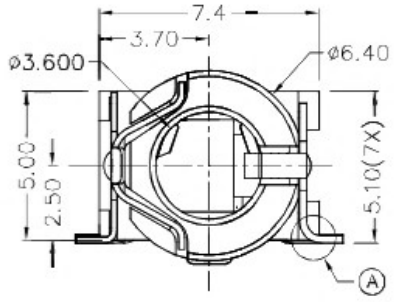
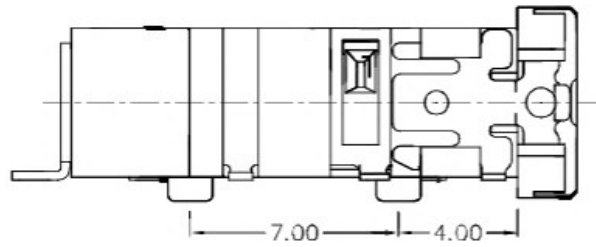
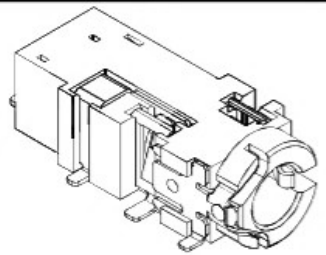
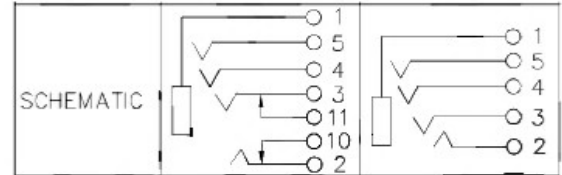
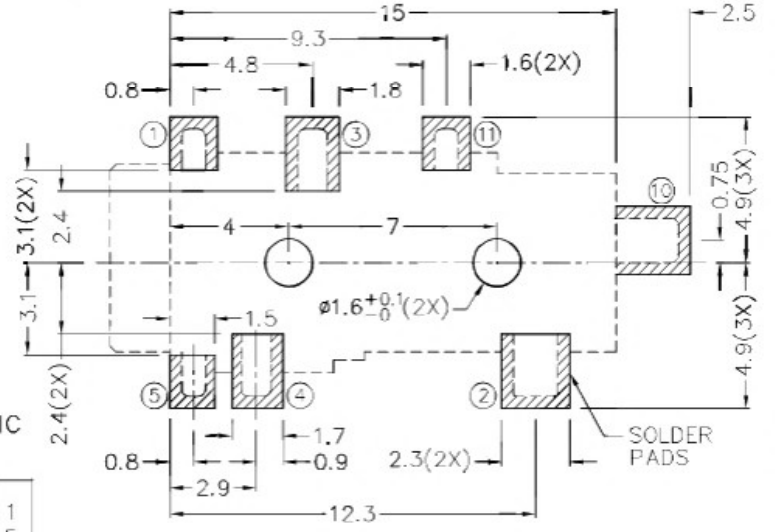
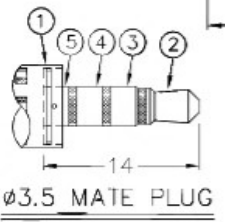
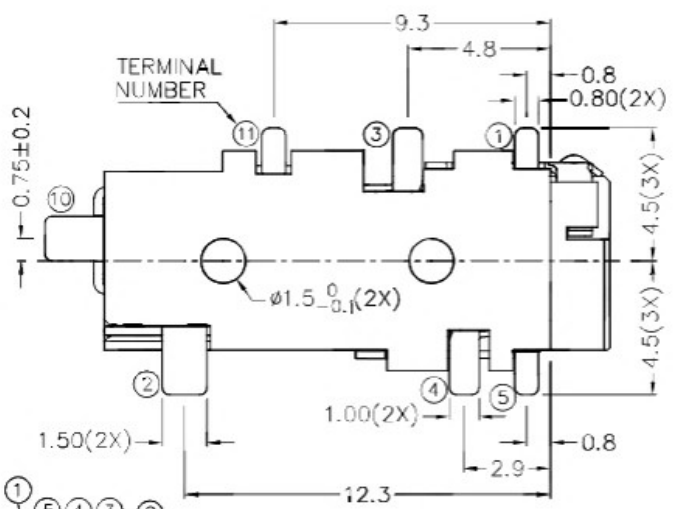

广东科斯达开关厂

| | | | | | |
|----------|---------|------|------------|----------|-----------------|
| DESIGN | T.Y.LI | DATE | 7-10-2003 | SCALE | 4:1 |
| DRAWING | G.P.YI | DATE | 29-12-2016 | MATERIAL | * |
| CHECK | H.L.TAN | DATE | 29-12-2016 | DWG. NO. | TZ\SH382D-A/1.0 |
| APPROVAL | | DATE | | SHEET | |

| | |
|-----------|-----------------------|
| PART NAME | 3.5mm SMD STEREO JACK |
| PART NO. | |

| | | | |
|----------------------|------------|-------|----|
| TOLERANCE UNLESS | 0.0±0.2 | UNIT: | mm |
| OTHERWISE SPECIFIED: | 0.00±0.1 | | |
| | 0.000±0.05 | | |

F E D C B A