

F

E

D

C

B

A

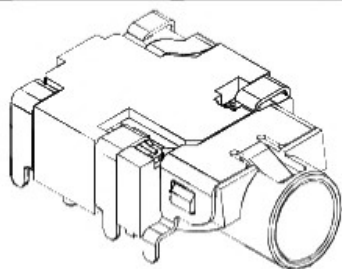

RoHS
Compliant

ZONE	SYMBOL	REVISION	APPROVAL	DATE

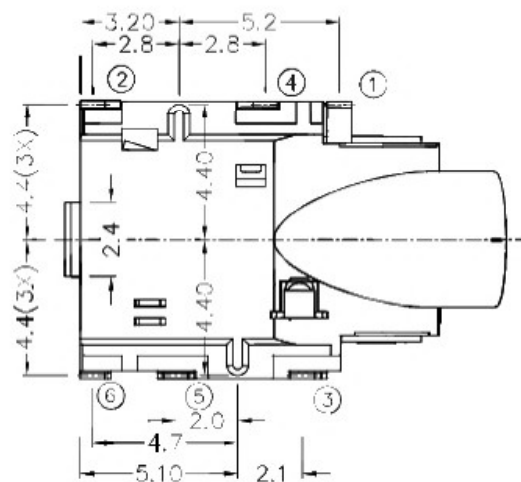
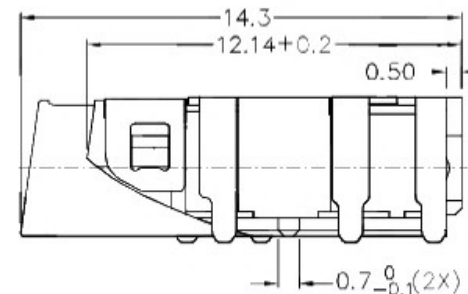
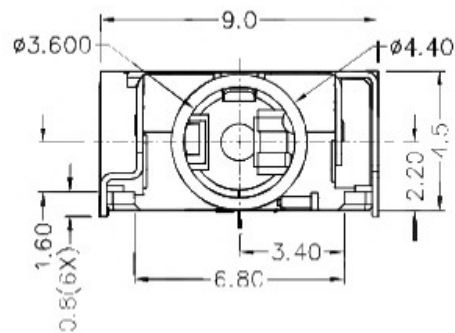
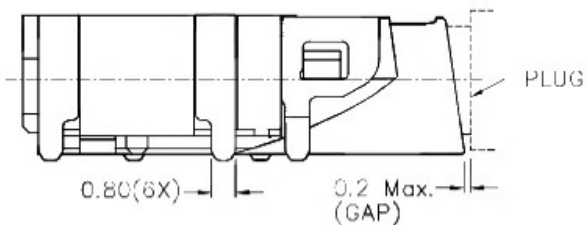

* MATERIAL

TERMINAL 1 : COPPER ALLOY
 TERMINAL 2 : COPPER ALLOY
 TERMINAL 3 : COPPER ALLOY
 TERMINAL 4 : COPPER ALLOY
 TERMINAL 5 : COPPER ALLOY
 TERMINAL 6 : COPPER ALLOY
 HOUSING : HIGH TEMP. PLASTIC
 INSULATOR : HIGH TEMP. PLASTIC

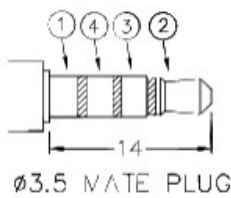
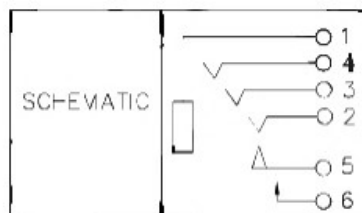
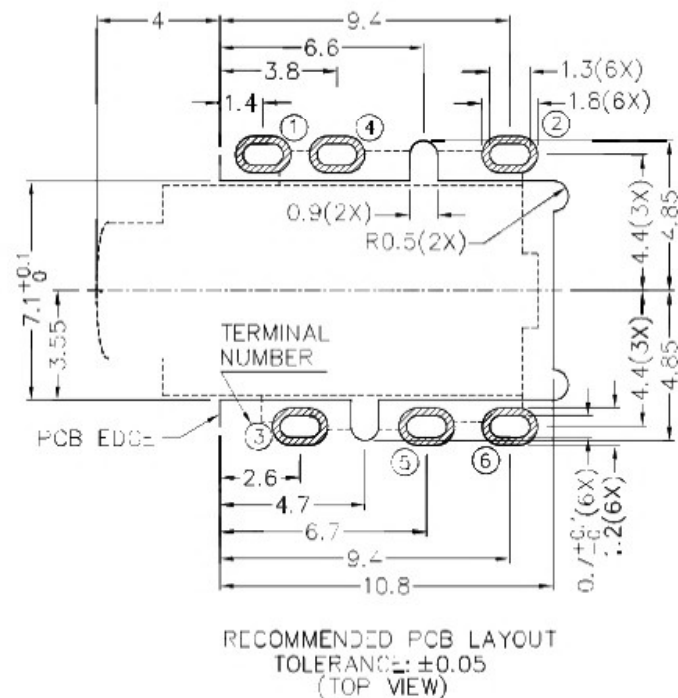

广东科斯达开关厂

PART NAME	3.5mm SMD STEREO JACK	TOLERANCE UNLESS	0.0±0.2	UNIT:	mm
PART NO.		OTHERWISE SPECIFIED:	0.00±0.1 0.000±0.05		

DESIGN	D.LIU	DATE	19-2-2013	SCALE	4:1
DRAWING	J.H.ZHOU	DATE	10-2-2017	MATERIAL	*
CHECK	T.Y.LI	DATE	10-2-2017	DWG. NO.	TZ\SH-573D-A/1.0
APPROVAL		DATE		SHEET	

F

E

D

C

B

A