

F E D C B A

ZONE	SYMBOL	REVISION	APPROVAL	DATE

RoHS  
Compliant

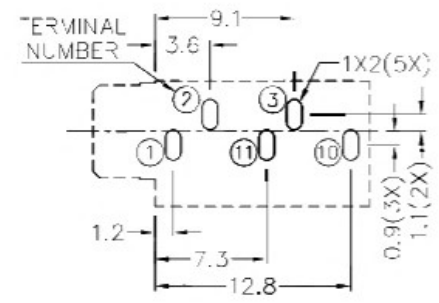
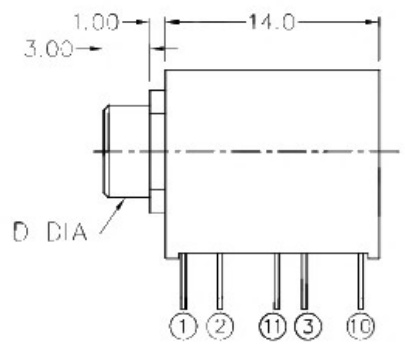
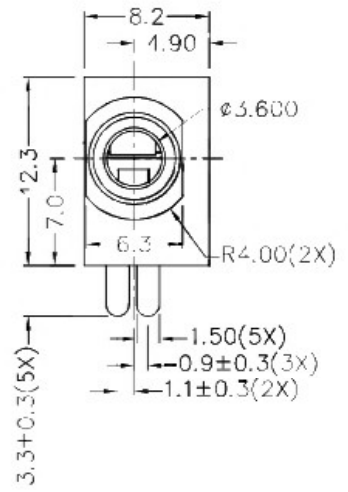
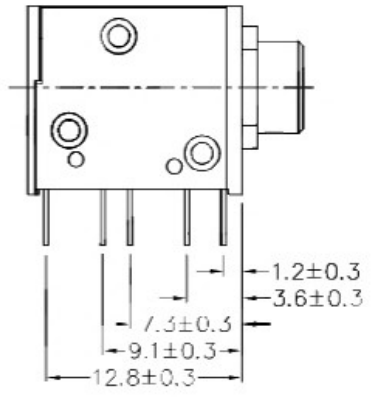
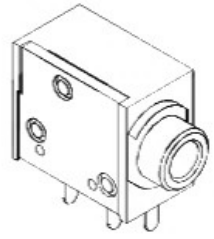

RECOMMENDED PCB LAYOUT  
TOLERANCE: ±0.05  
(TOP VIEW)

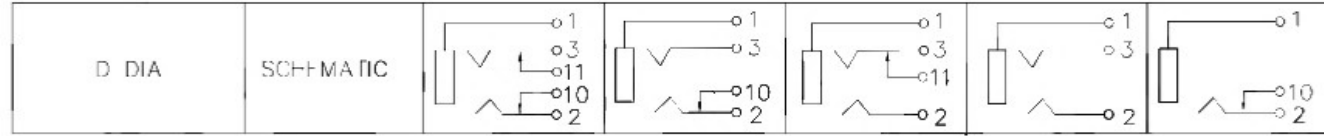
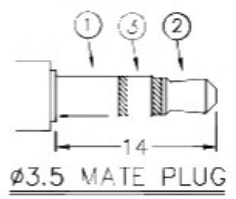

- \* MATERIAL
- TERMINAL 1 : BRASS
  - TERMINAL 2 : BRASS
  - TERMINAL 3 : BRASS
  - TERMINAL 10 : BRASS
  - TERMINAL 11 : BRASS
  - BUSHING : BRASS
  - SPRING : STAINLESS STEEL
  - HOUSING : THERMOPLASTIC
  - COVER : THERMOPLASTIC

广东科斯达开关厂

DESIGN	J.X.KUANG	DATE	21-7-2005	SCALE	2:1
DRAWING	H.Q.ZHOU	DATE	15-12-2016	MATERIAL	*
CHECK	T.Y.LI	DATE	15-12-2016	DWG. NO.	T7\SH366-B/1.0
APPROVAL		DATE		SHEET	

PART NAME	3.5mm STEREO JACK	TOLERANCE UNLESS	0.0±0.2	UNIT:
PART NO.		OTHERWISE SPECIFIED:	0.00±0.1 0.000±0.05	

F E D C B A