

F

E

D

C

B

A

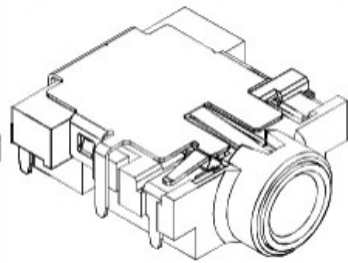

RoHS  
Compliant

ZONE	SYMBOL	REVISION	APPROVAL	DATE

1

1

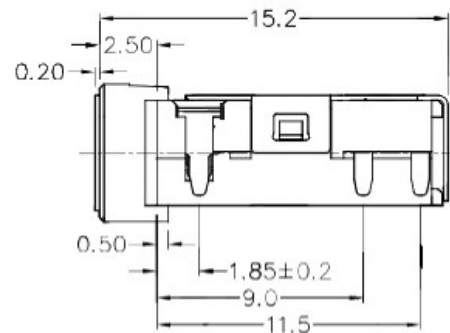
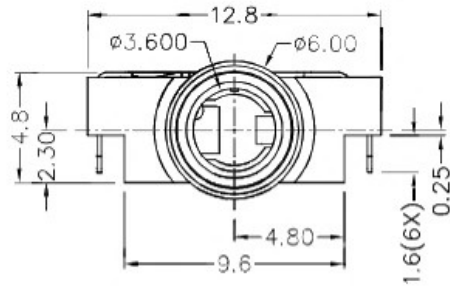
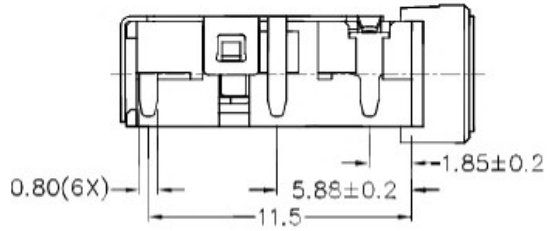

2

2

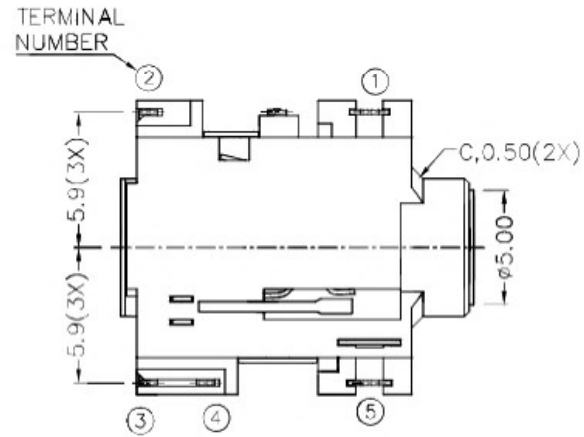

\* MATERIAL

- TERMINAL 1 : COPPER ALLOY
- TERMINAL 2 : COPPER ALLOY
- TERMINAL 3 : COPPER ALLOY
- TERMINAL 4 : COPPER ALLOY
- TERMINAL 5 : COPPER ALLOY
- SHIELD : COPPER ALLOY
- BUSHING : BRASS
- HOUSING : HIGH TEMP. PLASTIC

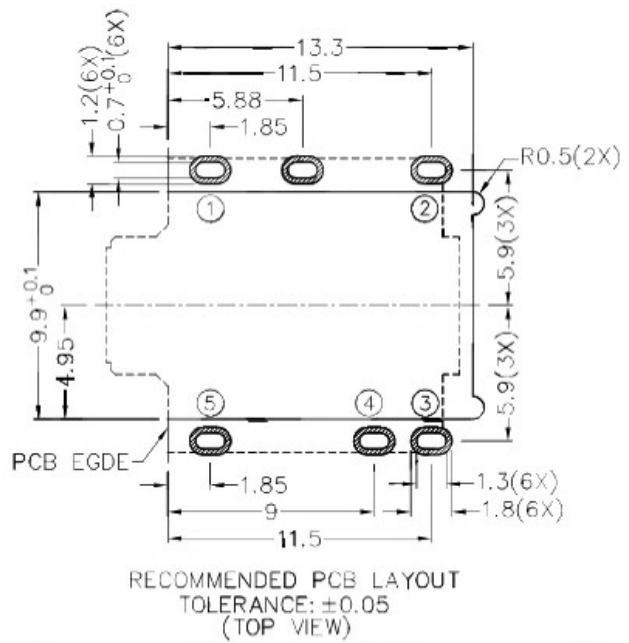

3

3

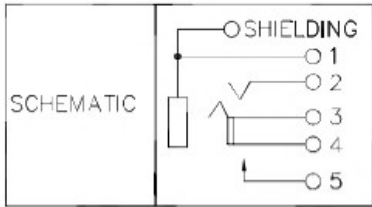
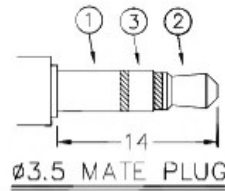

4

4

 **广东科斯达开关厂**

PART NAME	3.5mm SMD STEREO JACK	TOLERANCE UNLESS 0.0±0.2 0.00±0.1 OTHERWISE SPECIFIED: 0.000±0.05	UNIT: mm	DESIGN	T.Y.LI	DATE	10-1-2009	SCALE	3:1
				DRAWING	J.H.ZHOU	DATE	23-11-2016	MATERIAL	*
PART NO.				CHECK	H.L.TAN	DATE	23-11-2016	DWG. NO.	TZ\SH509DS-A/1.0
				APPROVAL		DATE		SHEET	

F

E

D

C

B

A