

F E D C B A

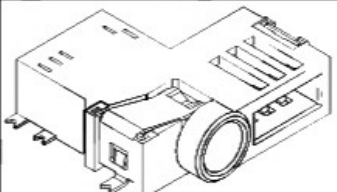

RoHS
Compliant

ZCNF	SYMBOL	REVISION	APPROVAL	DATE

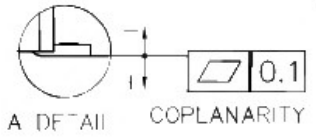
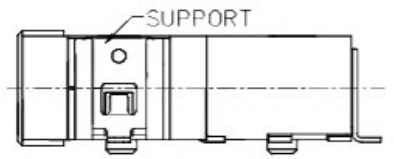
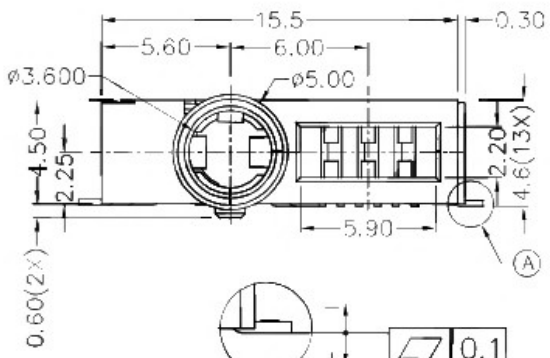
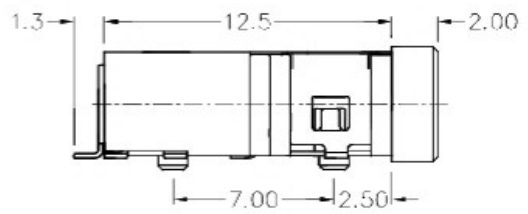

* MATERIAL

- TERMINAL 1 : COPPER ALLOY
- TERMINAL 2 : COPPER ALLOY
- TERMINAL 3 : COPPER ALLOY
- TERMINAL 4 : COPPER ALLOY
- TERMINAL 5 : COPPER ALLOY
- TERMINAL 10 : COPPER ALLOY
- TERMINAL 21 : COPPER ALLOY
- TERMINAL 22 : COPPER ALLOY
- TERMINAL 23 : COPPER ALLOY
- TERMINAL 31 : COPPER ALLOY
- TERMINAL 32 : COPPER ALLOY
- TERMINAL 33 : COPPER ALLOY
- SUPPORT : COPPER ALLOY
- HOUSING : HIGH TEMP. PLASTIC

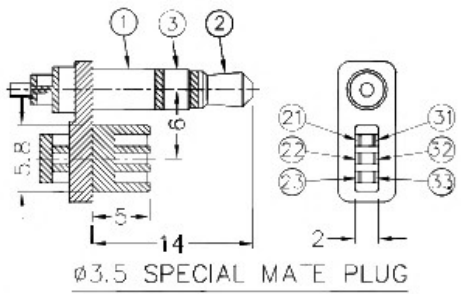
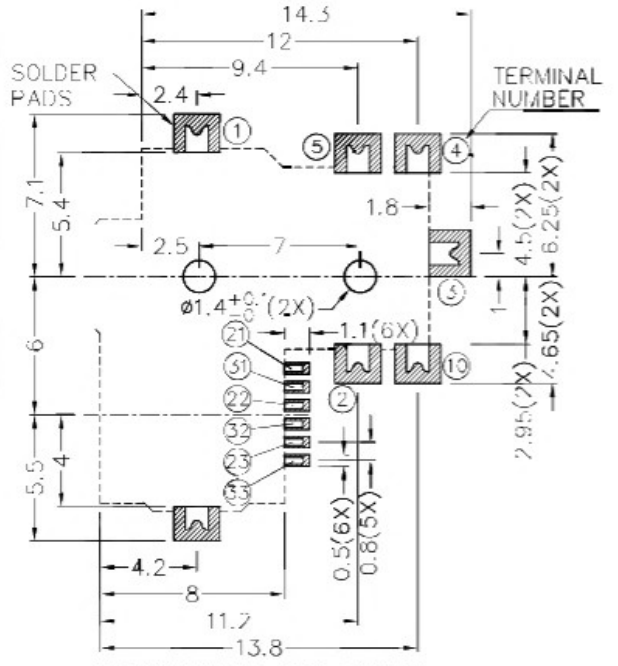
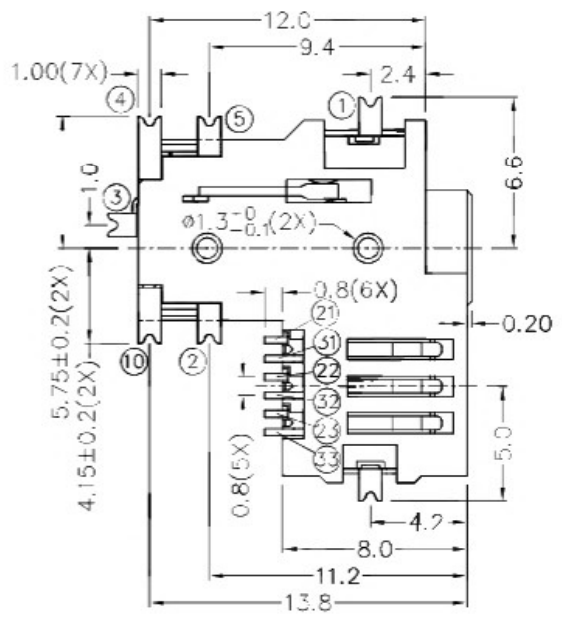
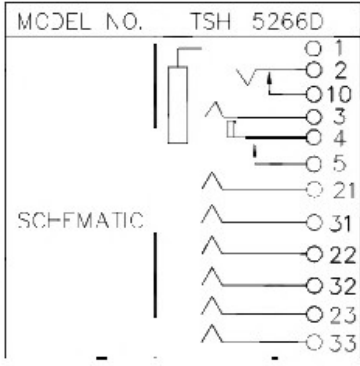

广东科斯达开关厂

PART NAME	5.5mm SMD STEREO JACK W/SIGNAL CONTACT	TOLERANCE	UNI FSS 0.0±0.2 0.00±0.1	UNIT:	mm
PART NO.		OTHERWISE SPECIFIED:	0.000±0.05		

DESIGN	G.P.YI	DATE	2-4-2010	SCALE	3:1
DRAWING	H.Q.ZHOU	DATE	17-1-2017	MATERIAL	*
CHECK	T.Y.LI	DATE	17-1-2017	DWG. NO.	TZ\SH526D-A/1.0
APPROVAL		DATE		SHEET	

F E D C B A