

F

E

D

C

B

A

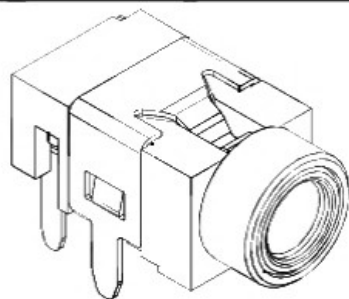

RoHS
Compliant

ZONE	SYMBOL	REVISION	APPROVAL	DATE

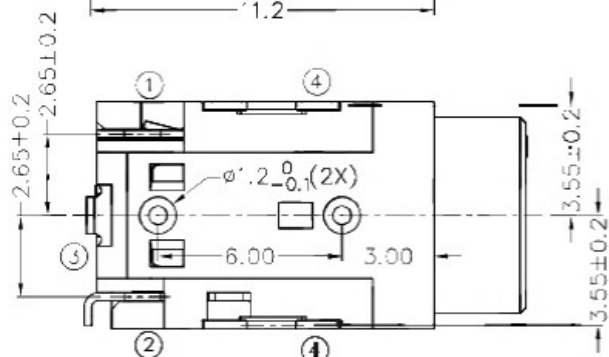
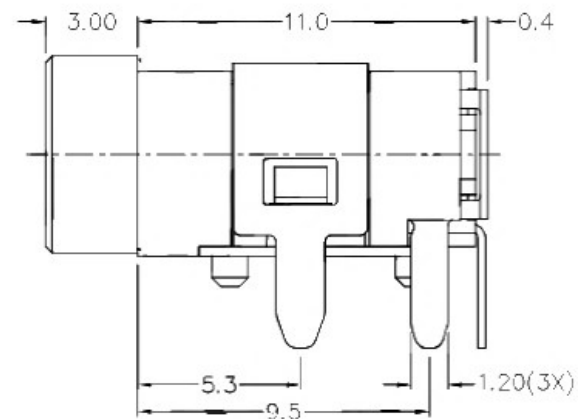
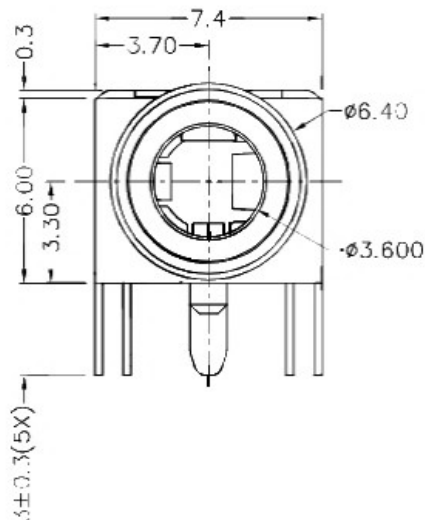
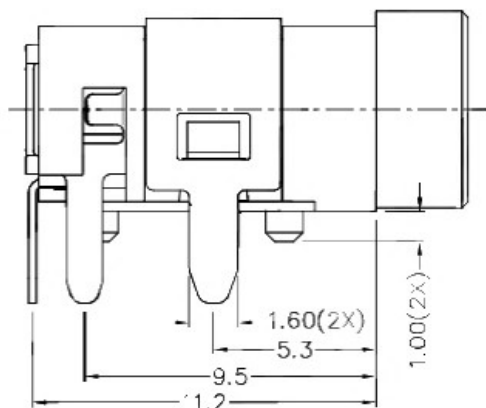

* MATERIAL

TERMINAL 1 : COPPER ALLOY
 TERMINAL 2 : COPPER ALLOY
 TERMINAL 3 : COPPER ALLOY
 TERMINAL 4 : COPPER ALLOY
 BUSHING : BRASS
 HOUSING : THERMOPLASTIC

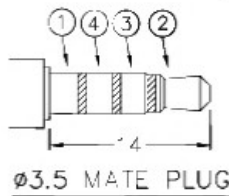
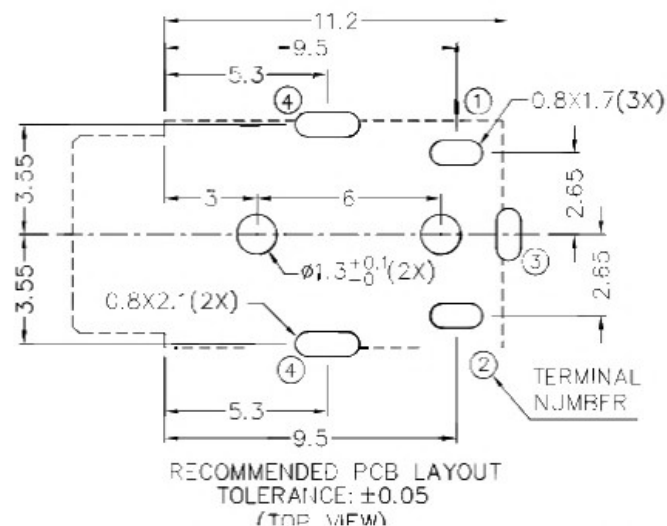
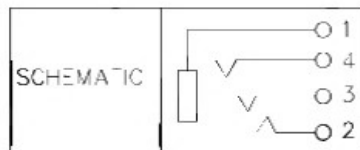

广东科斯达开关厂

PART NAME	3.5mm STFRFO JACK	TOLERANCE UNLESS	0.0-0.2	UNIT:	mm
PART NO.		OTHERWISE SPECIFIED:	0.00 \pm 0.1 0.000 \pm 0.05		

DESIGN	H.I.TAN	DATE	15-4-2011	SCALE	4:1
DRAWING	J.H.ZHOU	DATE	3-1-2017	MATERIAL	*
CHECK	T.Y.LI	DATE	3-1-2017	DWG. NO.	TZ\SH394M-B/1.0
APPROVAL		DATE		SHEET	

F

E

D

C

B

A