

F

E

D

C

B

A

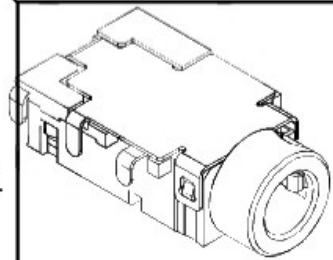

RoHS
Compliant

ZONE	SYMBOL	REVISION	APPROVAL	DATE

1

1

2

2

3

3

4

4

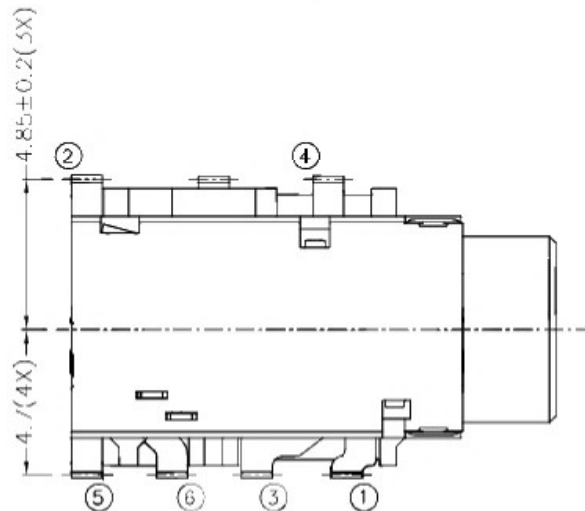
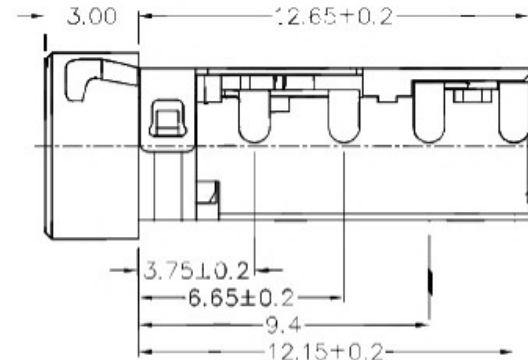
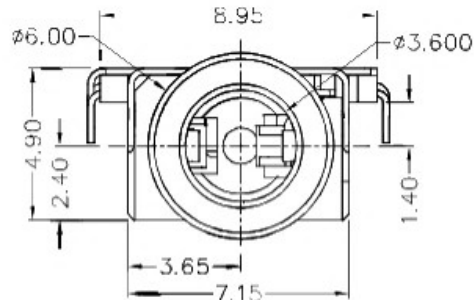
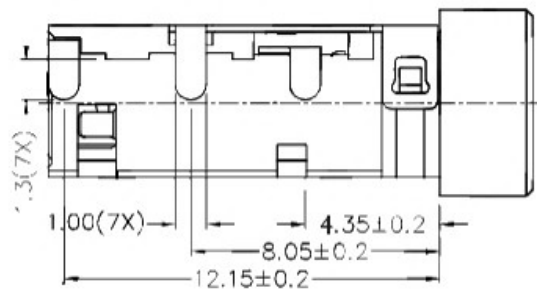

* MATERIAL

TERMINAL 1 : COPPER ALLOY
 TERMINAL 2 : COPPER ALLOY
 TERMINAL 3 : COPPER ALLOY
 TERMINAL 4 : COPPER ALLOY
 TERMINAL 5 : COPPER ALLOY
 TERMINAL 6 : COPPER ALLOY
 SHIELD : BRASS
 HOUSING : HIGH TEMP. PLASTIC
 INSULATOR : HIGH TEMP. PLASTIC

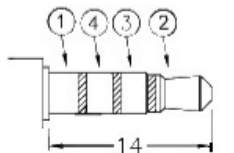
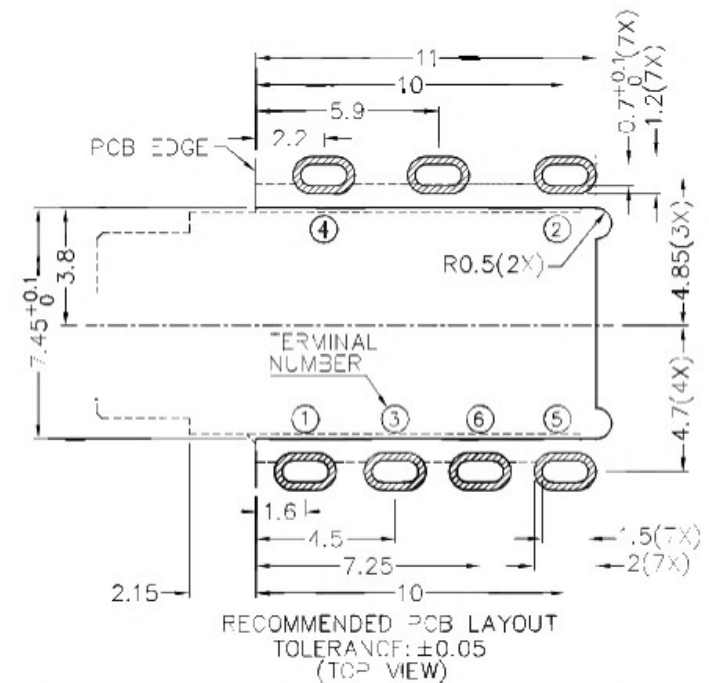

∅3.5 MATE PLUG

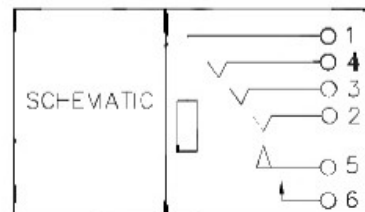

 广东科斯达开关厂

DESIGN	H.L.TAN	DATE	21-8-2013	SCALE	4:1
DRAWING	J.H.ZHOU	DATE	14-2-2017	MATERIAL	*
CHECK	T.Y.LI	DATE	14-2-2017	DWG. NO.	TZ\SH583DS-A/1.0
APPROVAL		DATE		SHEET	

PART NAME	3.5mm SMD STEREO JACK	TOLERANCE UNLESS	0.0±0.2	UNIT:	mm
PART NO.		OTHERWISE SPECIFIED:	0.00±0.1 0.000±0.05		

F

E

D

C

B

A