

F

E

D

C

B

A

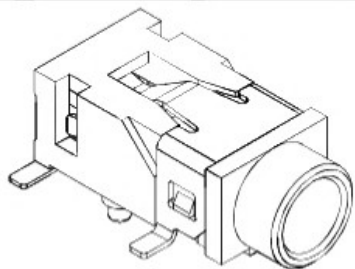

RoHS
Compliant

ZONE	SYMBOL	REVISION	APPROVAL	DATE

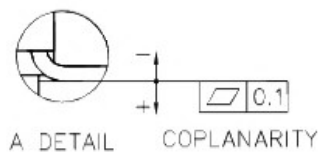
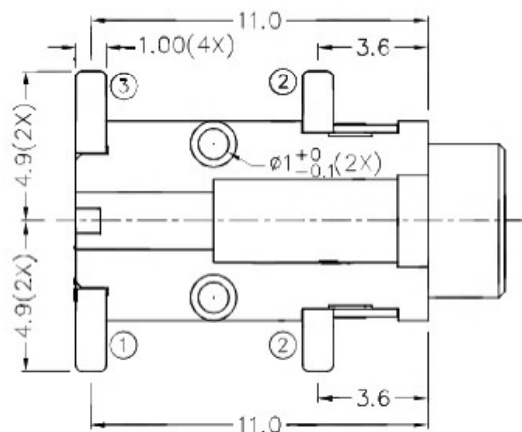
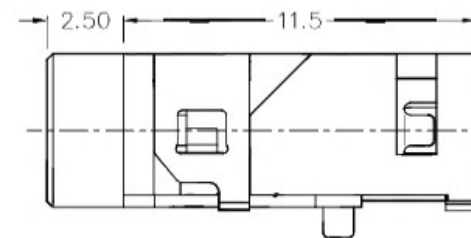
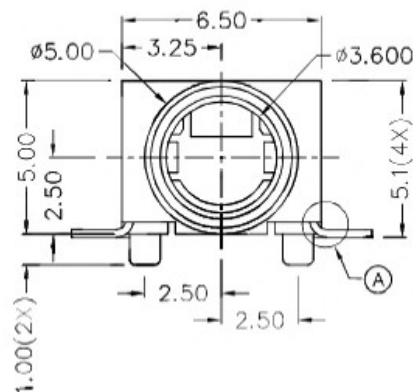
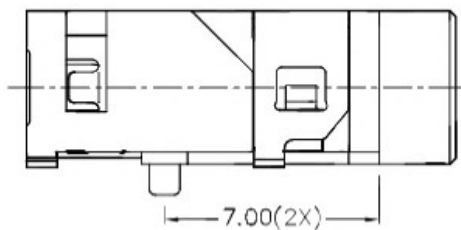

* MATERIAL

TERMINAL 1 : COPPER ALLOY
TERMINAL 2 : COPPER ALLOY
TERMINAL 3 : COPPER ALLOY
HOUSING : HIGH TEMP. PLASTIC

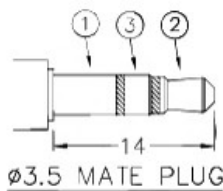
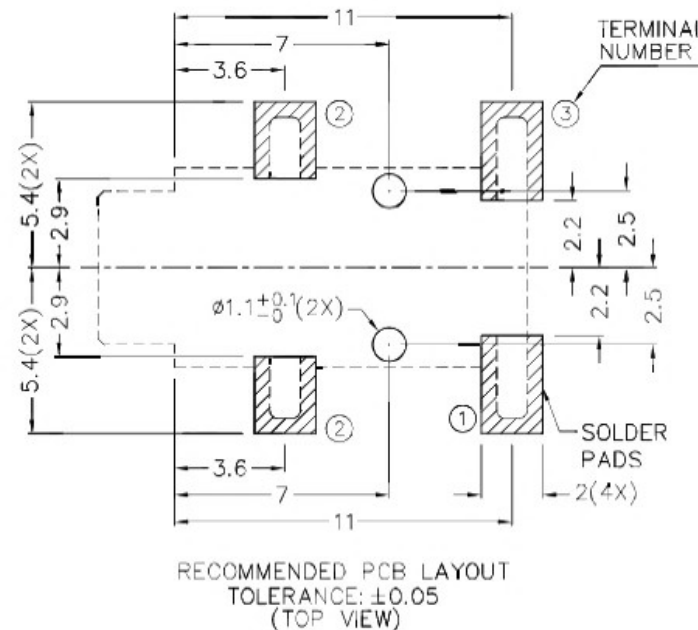
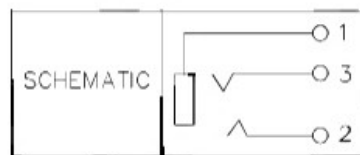

 广东科斯达开关厂

PART NAME	3.5mm SMD STEREO JACK	TOLERANCE UNLESS	0.0±0.2	UNIT:	mm
PART NO.		OTHERWISE SPECIFIED:	0.00±0.1 0.000±0.05		

DESIGN	J.JIANG	DATE	3-5-2004	SCALE	4:1
DRAWING	CH.XIONG	DATE	16-12-2016	MATERIAL	*
CHECK	T.Y.LI	DATE	16-12-2016	DWG. NO.	TZ\SH373D-A/1.0
APPROVAL		DATE		SHEET	

F

E

D

C

B

A