

F

E

D

C

B

A

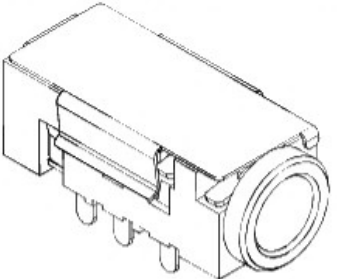

RoHS
Compliant

ZC/NF	SYMBOL	REVISION	APPROVAL	DATE

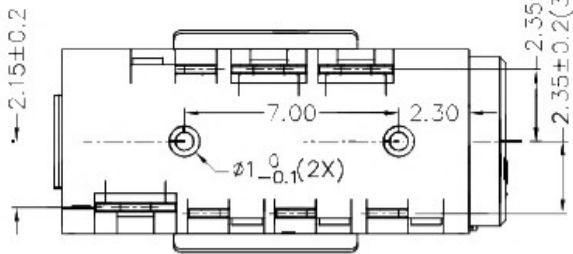
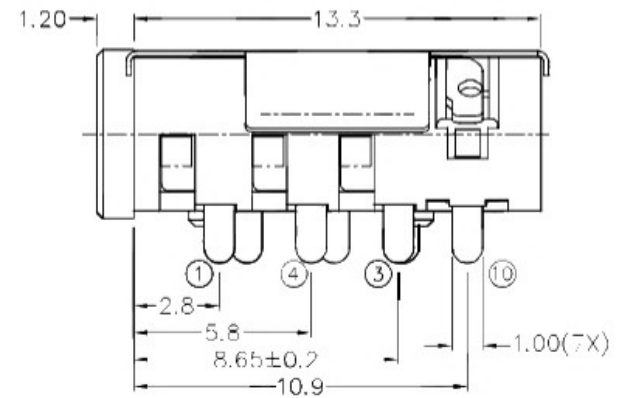
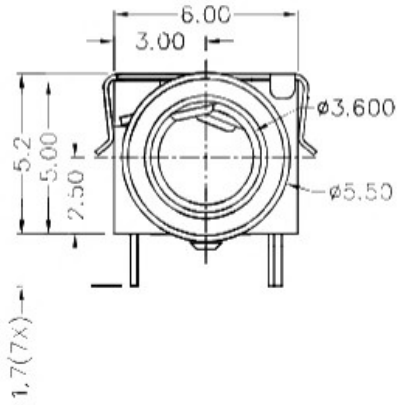
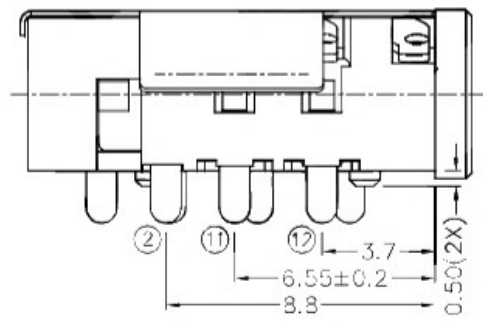

* MATERIAL

- TERMINAL 1 : COPPER ALLOY
- TERMINAL 2 : COPPER ALLOY
- TERMINAL 3 : COPPER ALLOY
- TERMINAL 4 : COPPER ALLOY
- TERMINAL 10 : BRASS
- TERMINAL 11 : BRASS
- TERMINAL 12 : BRASS
- SHIELD : STAINLESS STEEL
- HOLDING : HIGH TEMP. PLASTIC

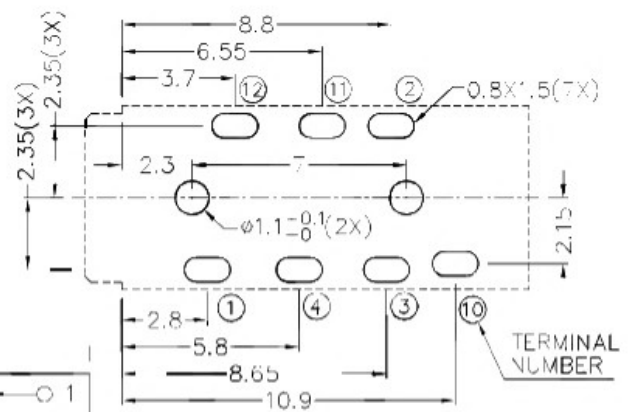

RECOMMENDED PCB LAYOUT
TOLERANCE: ±0.05
(TOP VIEW)

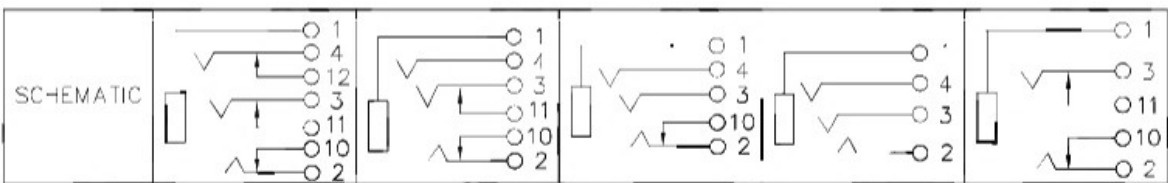
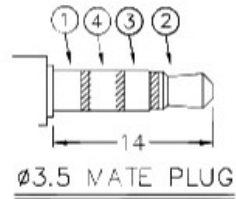

广东科斯达开关厂

DESIGN	T.Y.LI	DATE	25- / -2007	SCALE	4:1
DRAWING	J.CH.OU	DATE	3-1-2017	MATERIAL	*
CHECK	H.L.TAN	DATE	3-1-2017	DWG. NO.	TZ\SH391SI-3-A/1.0
APPROVAL		DATE		SHEET	

PART NAME	3.5mm STEREO JACK W/HANDING SHIELD	TOLERANCE UNLESS	0.0±0.2	UNIT:	mm
PART NO.		OTHERWISE SPECIFIED:	0.00±0.1 0.000±0.05		

F

E

D

C

B

A