

F

E

D

C

B

A

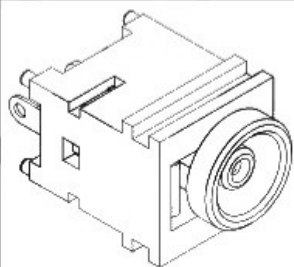

RoHS
Compliant

ZONE	SYMBOL	REVISION	APPROVAL	DATE

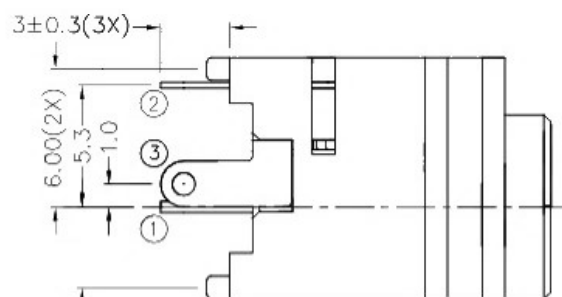
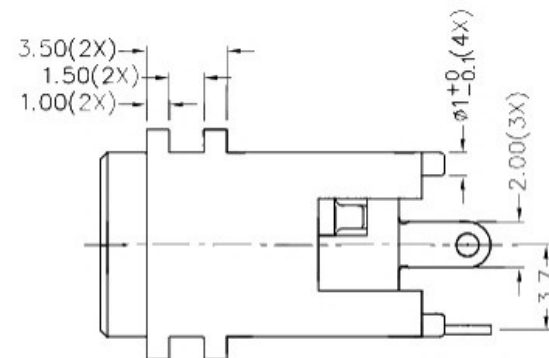
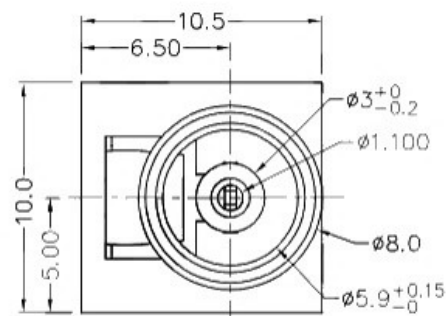
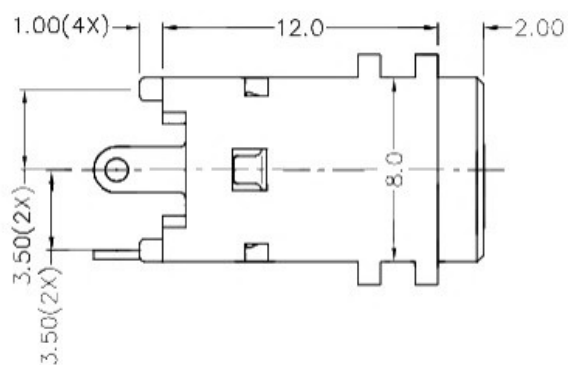

* MATERIAL

TERMINAL 1 : BRASS
 TERMINAL 2 : COPPER ALLOY
 TERMINAL 3 : BRASS
 HOUSING : THERMOPLASTIC

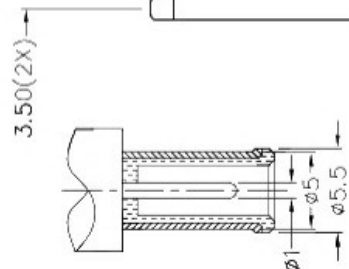

DC MATE PLUG

SCHEMATIC

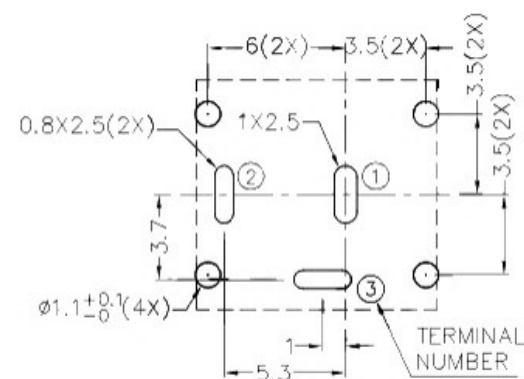
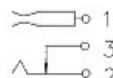

RECOMMENDED PCB LAYOUT
 TOLERANCE: ±0.05
 (TOP VIEW)

广东科斯达开关厂

PART NAME	DC POWER SOCKET	TOLERANCE UNLESS	0.0±0.2	UNIT:
PART NO.		OTHERWISE SPECIFIED:	0.00±0.1 0.000±0.05	

DESIGN	G.P.YI	DATE	17-2-2011	SCALE	3:1
DRAWING	J.H.ZHOU	DATE	4-11-2016	MATERIAL	*
CHECK	T.Y.LI	DATE	4-11-2016	DWG. NO.	TZ\DC092-B/1.0
APPROVAL		DATE		SHEET	

F

E

D

C

B

A