

F

E

D

C

B

A

ZONE	SYMBOL	REVISION	APPROVAL	DATE

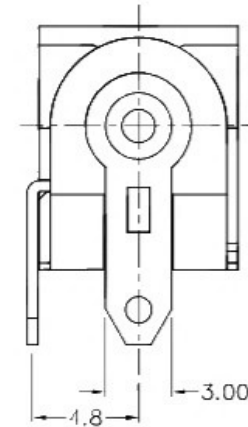
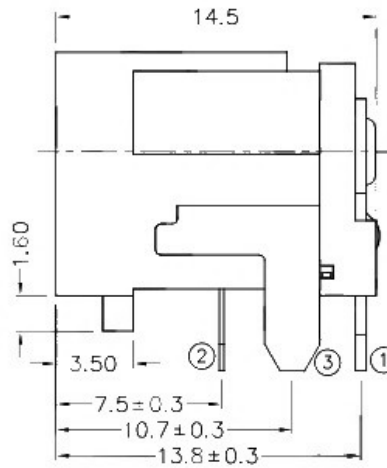
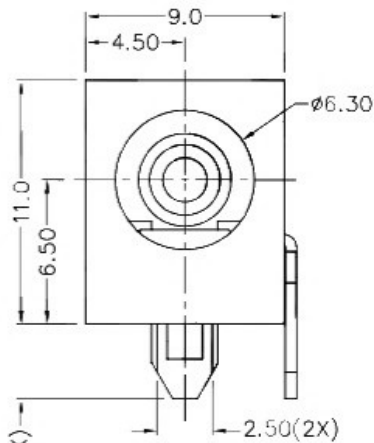
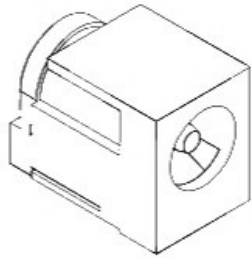

RoHS
Compliant

3.4±0.3(3X)

* MATERIAL

CENTRE PIN : COPPER
 TERMINAL 1 : BRASS
 TERMINAL 2 : COPPER ALLOY
 TERMINAL 3 : BRASS
 HOUSING : THERMOPLASTIC
 COVER : THERMOPLASTIC

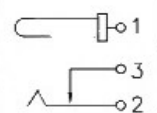
MODEL NO.	
SCHEMATIC	
CENTER PIN	<p>ø2mm</p> <p>ø2.5mm</p>

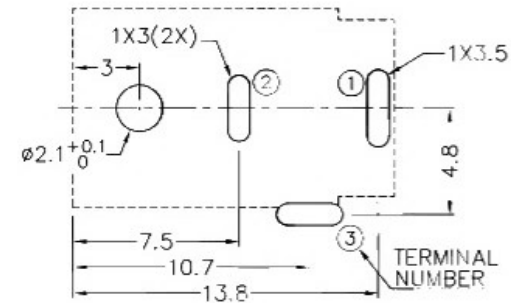
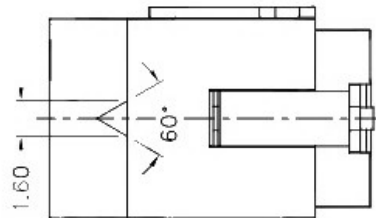

RECOMMENDED PCB LAYOUT
 TOLERANCE: ±0.05
 (TOP VIEW)

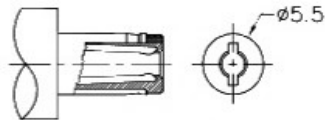

DC MATE PLUG

 广东科斯达开关厂

DESIGN	J.X.KUANG	DATE	8-12-2004	SCALE	3:1
DRAWING	J.H.ZHOU	DATE	14-10-2016	MATERIAL	*
CHECK	T.Y.LI	DATE	14-10-2016	DWG. NO.	TZ\DC061-B/1.0
APPROVAL		DATE		SHEET	

PART NAME	DC POWER SOCKET	TOLERANCE UNLESS	0.0±0.2	UNIT:	
PART NO.		OTHERWISE SPECIFIED:	0.00±0.1 0.000±0.05	mm	

F

E

D

C

B

A