

F

E

D

C

B

A

ZONE	SYMBOL	REVISION	APPROVAL	DATE

RoHS
Compliant

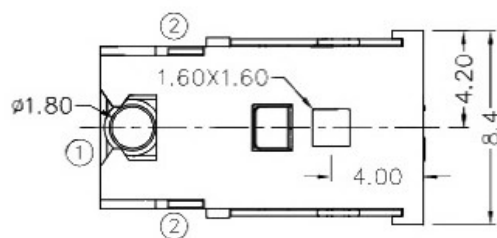
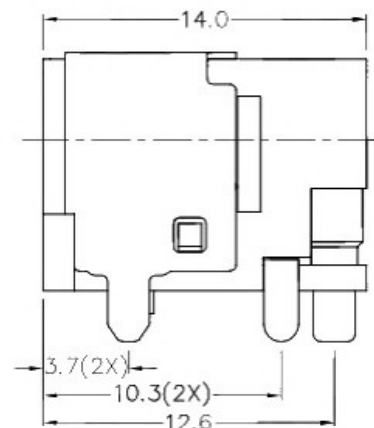
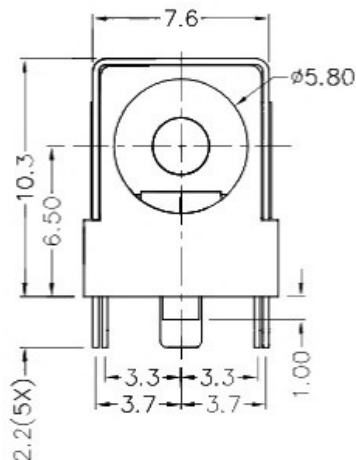
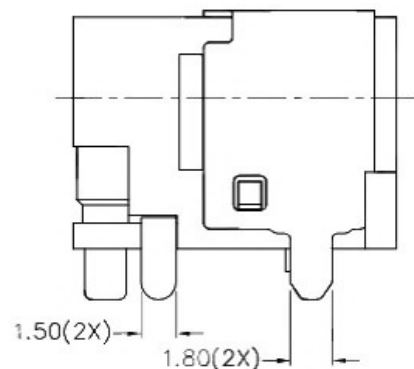
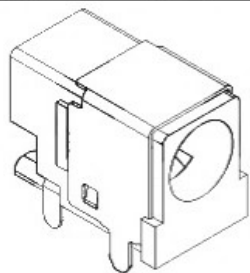

* MATERIAL

TERMINAL 1 : COPPER
TERMINAL 2 : COPPER ALLOY
SHIELD : BRASS
HOUSING : THERMOPLASTIC

MODEL NO.	
SCHEMATIC	$\phi 1$
	$\phi 2$
CENTER PIN	$\phi 2\text{mm}$
	$\phi 2.5\text{mm}$

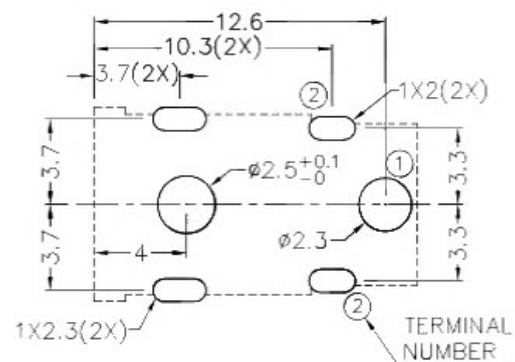

RECOMMENDED PCB LAYOUT
TOLERANCE: ± 0.05
(TOP VIEW)

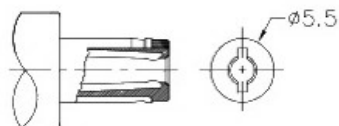

DC MATE PLUG

广东科斯达开关厂

DESIGN	T.Y.LI	DATE	11-10-2003	SCALE	3:1
DRAWING	J.H.ZHOU	DATE	7-11-2016	MATERIAL	*
CHECK	H.L.TAN	DATE	7-11-2016	DWG. NO.	TZ\DC044S2-1-B/1.0
APPROVAL		DATE		SHEET	

PART NAME	DC POWER SOCKET	TOLERANCE UNLESS	0.0 \pm 0.2	UNIT:
PART NO.		OTHERWISE SPECIFIED:	0.00 \pm 0.1 0.000 \pm 0.05	

F

E

D

C

B

A