

F

E

D

C

B

A

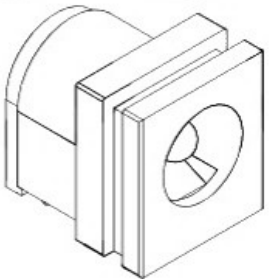

RoHS  
Compliant

ZONE	SYMBOL	REVISION	APPROVAL	DATE

1

1

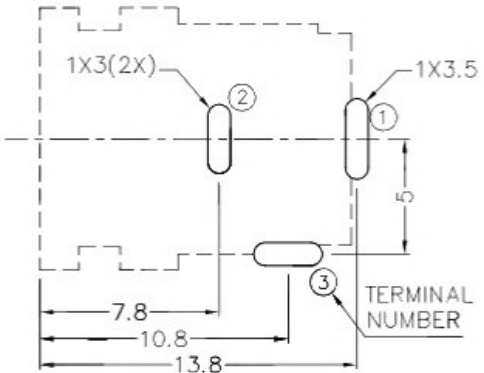
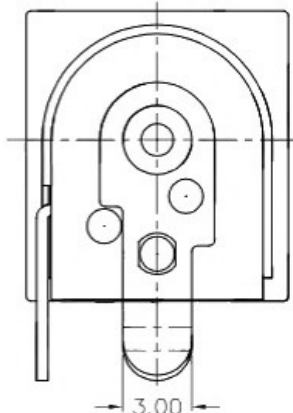
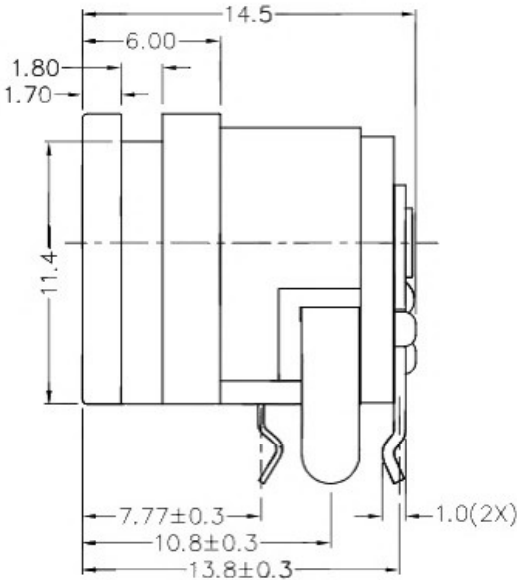
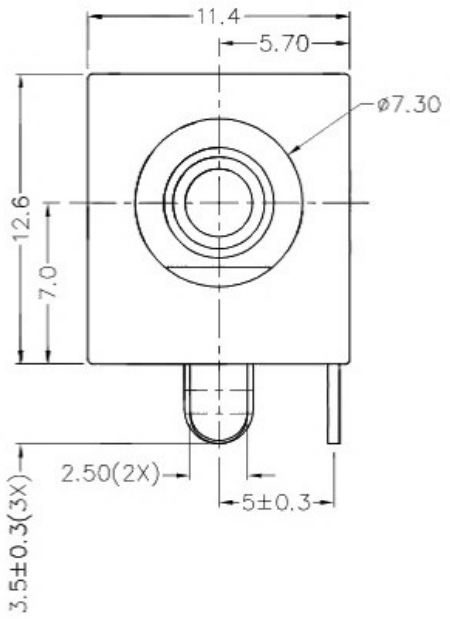

RECOMMENDED PCB LAYOUT  
TOLERANCE: ±0.05  
(TOP VIEW)

2

2

3

3

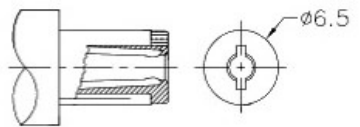

DC MATE PLUG

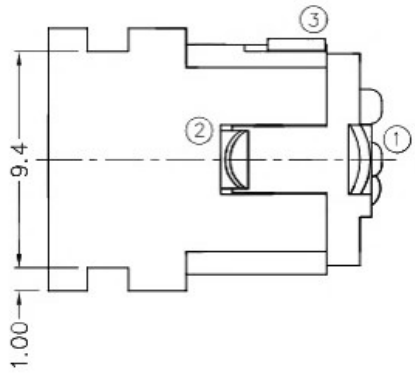

SCHEMATIC	
CENTER PIN	φ2mm
	φ2.5mm
	φ3mm

\* MATERIAL

- CENTRE PIN : COPPER
- TERMINAL 1 : BRASS
- TERMINAL 2 : COPPER ALLOY
- TERMINAL 3 : BRASS
- HOUSING : THERMOPLASTIC
- COVER : THERMOPLASTIC

4

4

广东科斯达开关厂

DESIGN	J.X.KUANG	DATE	11-10-2003	SCALE	3:1
DRAWING	L.L.ZHANG	DATE	2-11-2016	MATERIAL	*
CHECK	T.Y.LI	DATE	2-11-2016	DWG. NO.	TZ\DC040H-2-B/1.0
APPROVAL		DATE		SHEET	

F

E

D

C

B

A

PART NAME	HIGH CURRENT DC POWER SOCKET	TOLERANCE UNLESS	0.0±0.2	UNIT:	
PART NO.		OTHERWISE SPECIFIED:	0.00±0.1 0.000±0.05	mm	