

F

E

D

C

B

A

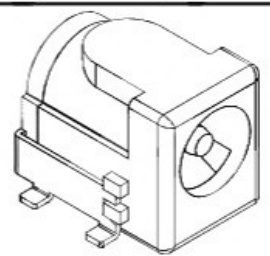

RoHS
Compliant

ZONE	SYMBOL	REVISION	APPROVAL	DATE
C2	△	11.2 CHANGED TO 11.1	J.X.KUANG	24-6-2019

1

1

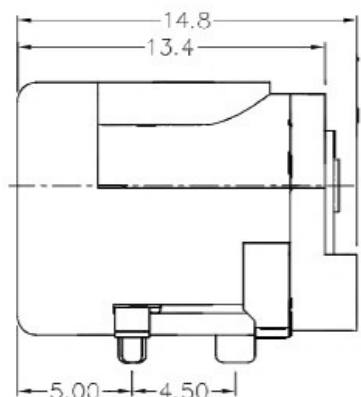
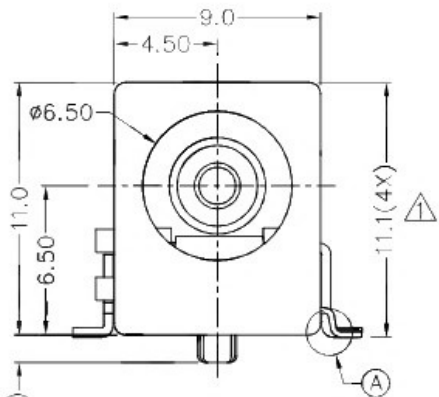
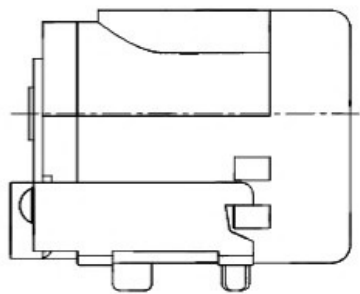

2

2

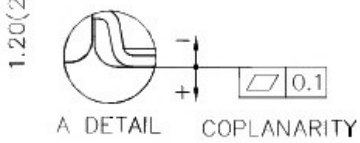
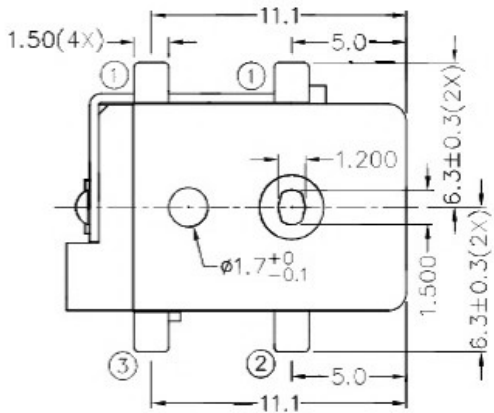

*** MATERIAL**
 CENTRE PIN : COPPER
 TERMINAL 1 : BRASS
 TERMINAL 2 : COPPER ALLOY
 TERMINAL 3 : BRASS
 HOUSING : HIGH TEMP. PLASTIC
 COVER : HIGH TEMP. PLASTIC

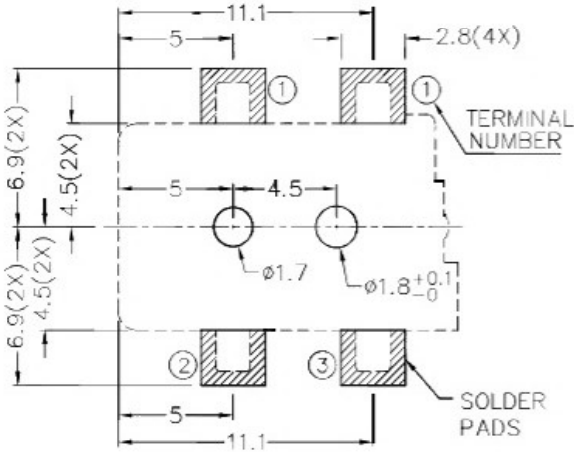

3

3

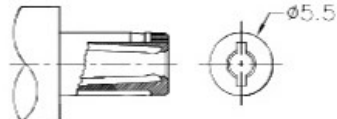

DC MATE PLUG

SCHEMATIC	
CENTER PIN	ø2mm
	ø2.5mm

RECOMMENDED PCB LAYOUT
TOLERANCE: ±0.05
(TOP VIEW)

4

4

广东科斯达开关厂

DESIGN	K.Y.AU-YEUNG	DATE	9-10-2003	SCALE	3:1
DRAWING	T.Y.LI	DATE	24-6-2019	MATERIAL	*
CHECK	H.L.TAN	DATE	24-6-2019	DWG. NO.	TZ\DC016H-A/1.1
APPROVAL		DATE		SHEET	

PART NAME	HIGH CURRENT SMD DC POWER SOCKET	TOLERANCE UNLESS	0.0±0.2	UNIT:
PART NO.		OTHERWISE SPECIFIED:	0.00±0.1 0.000±0.05	

F

E

D

C

B

A