

ZONE	SYMBOL	REVISION	APPROVAL	DATE
		ADJUST THE RECOMMENDED DC	J.X.KUANG	8-10-2019
		MATING PLUG		

RoHS
Compliant

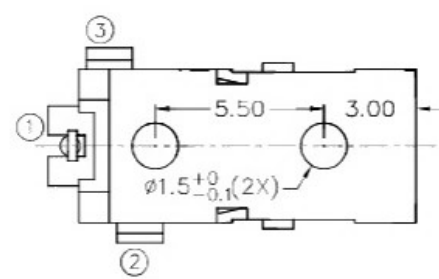
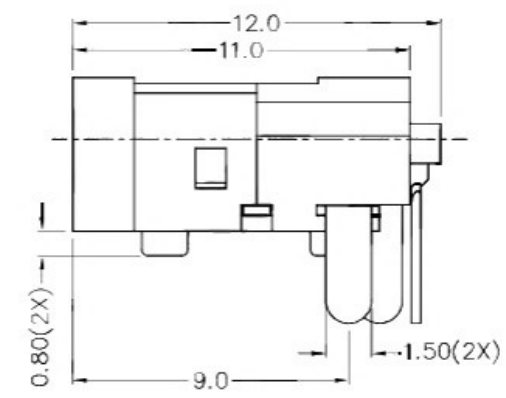
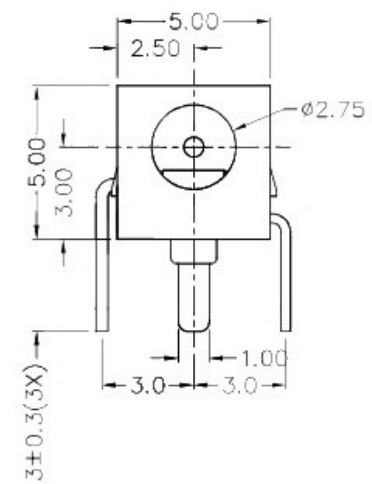
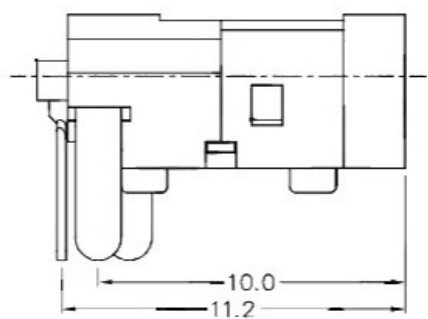
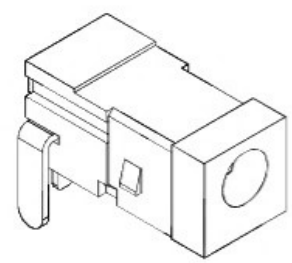

* MATERIAL
 TERMINAL 1 : COPPER
 TERMINAL 2 : COPPER ALLOY
 TERMINAL 3 : BRASS
 HOUSING : THERMOPLASTIC

MODEL NO.	
SCHEMATIC	
CENTER PIN	∅0.650mm

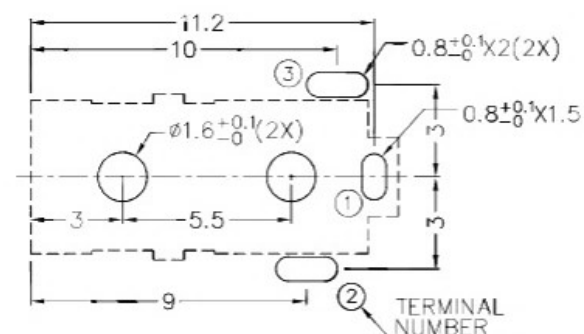

RECOMMENDED PCB LAYOUT
 TOLERANCE: ±0.05
 (TOP VIEW)

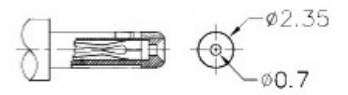

RECOMMENDED
 DC MATING PLUG

广东科斯达开关厂

PART NAME		DC POWER SOCKET		TOLERANCE UNLESS		0.0±0.2		UNIT:		DESIGN		T.Y.LI		DATE		10-10-2003		SCALE		4:1	
PART NO.				OTHERWISE SPECIFIED:		0.00±0.1		mm		DRAWING		H.Q.ZHOU		DATE		8-10-2019		MATERIAL		*	
						0.000±0.05				CHECK		H.L.TAN		DATE		8-10-2019		DWG. NO.		TZ\DC027-B/1.1	
										APPROVAL				DATE				SHEET			