

F

E

D

C

B

A

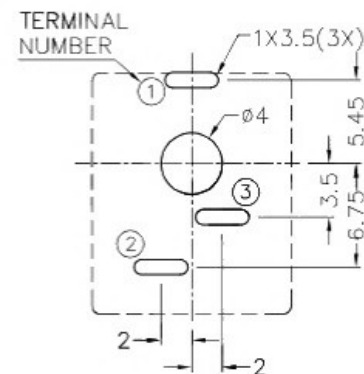
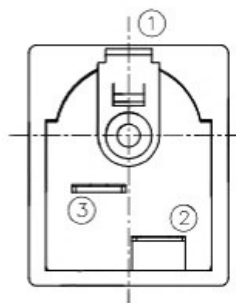
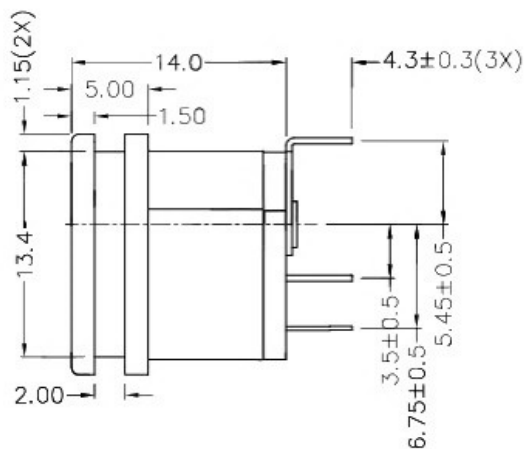
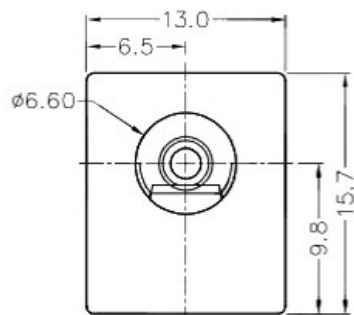
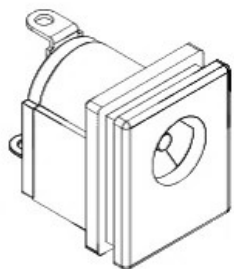

RECOMMENDED PCB LAYOUT  
TOLERANCE: ±0.05  
(TOP VIEW)

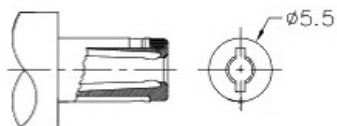

DC MATE PLUG

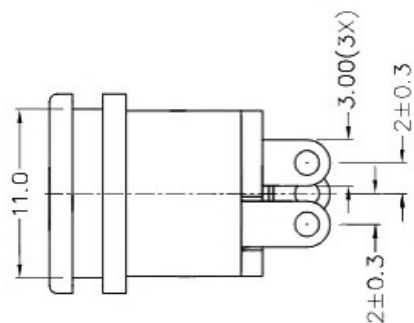

\* MATERIAL

CENTRE PIN : COPPER  
TERMINAL 1 : BRASS  
TERMINAL 2 : COPPER ALLOY  
TERMINAL 3 : BRASS  
HOUSING : THERMOPLASTIC  
COVER : THERMOPLASTIC

MODEL NO.	
SCHEMATIC	
CENTER PIN	1.65mm
	2mm
	2.5mm

ZONE	SYMBOL	REVISION	APPROVAL	DATE

RoHS  
Compliant

广东科斯达开关厂

PART NAME	DC POWER SOCKET	TOLERANCE UNLESS	0.0±0.2	UNIT:		DESIGN	J.X.KUANG	DATE	3-7-2004	SCALE	3:1
PART NO.		OTHERWISE SPECIFIED:	0.00±0.1 0.000±0.05	mm		DRAWING	J.H.ZHOU	DATE	30-11-2016	MATERIAL	*
					CHECK	T.Y.LI	DATE	30-11-2016	DWG. NO.	TZ\DC008-B/1.0	
					APPROVAL		DATE		SHEET		

F

E

D

C

B

A