

RoHS Compliant

NOTES:

1. ELECTRICAL:
 - 1) VOLTAGE CURRENT RATING: 2AMP,30V AC;
 - 2) INSULATION RESISTANCE: 1000MΩ MIN;
 - 3) CONTACT RESISTANCE: 30mΩ MAX;
 - 4) WITHSTANDING VOLTAGE: 500V AC;
 - 5) OPERATING TEMPERATURE:-55°C TO +85°C.
2. Mechanical:
 - 1) Mating Force: 35N MAX
 - 2) Unmating Force: 10N MIN.
3. DIMENSIONS MARKED "▼" TO BE CHECKED BY Q.C & IPQC.
4. PART NO

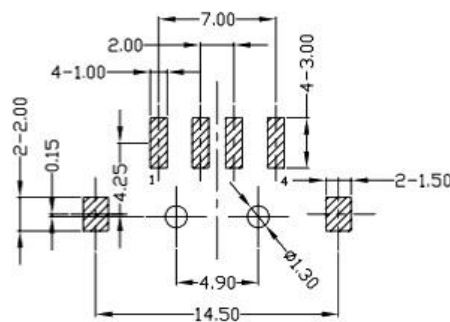
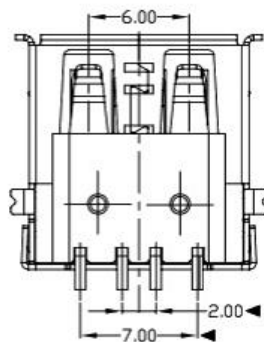
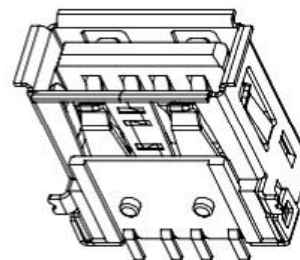
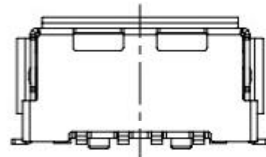
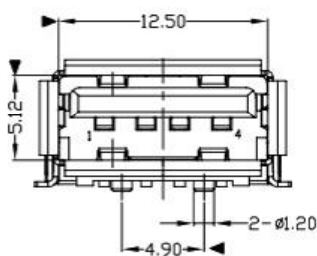
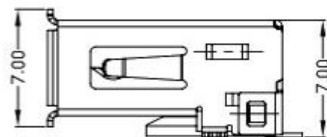
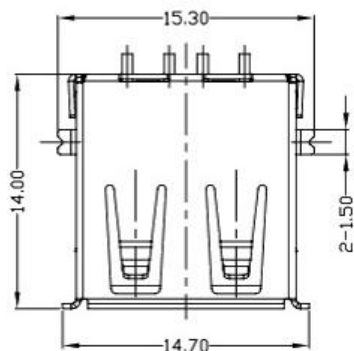

RECOMMENDED PCB LAYOUT

1:Au 1U*
6:Au 30U*

W:WHITE
B:BLACK

1:PBT
2:PA6T
3:PA9T
4:LCP

⑤	MID PLATE	1	STAINLESS STEEL	Au . PLATING.	T=0.15mm
④	SHELL	1	STAINLESS STEEL	Au . PLATING.	T=0.30mm
③	TERMINAL-B	1	TABLE 2:	TABLE 2:	T=0.12mm
②	TERMINAL-A	1	TABLE 2:	TABLE 2:	T=0.12mm
①	INSULATOR	1	HIGH TEMP	Black	
NO.	PART NAME	QTY	MATERIAL	DESCRIPTION	REMARK

UNLESS OTHERWISE, GENERAL TOLERANCE:

X.xxx ±0.10
X.xx ±0.20
X.x ±0.30
X. ±0.38

ANGULAR:

X.xx ±1°
X.x ±3°
X. ±5°

广东科斯达开关厂

TITLE: USB connector

P/N: Detail See PART NO. LIST

MODEL:

DRAW NO.:

THIRD ANGLE PROJECTION



UNIT:

mm

SCALE:

1:1

SIZE:

A4

SHEET:

1/1

JH2016-080	X2	随工程图上升版本次	2016.06.15	陈少兵	DESIGN	陈少兵	2016.06.15
JH2016-071	X1	新增规格	2016.06.10	陈少兵	CHECK	郑小伟	2016.06.15
20151224001	X	NEW DRAWING	2016.05.05	陈少兵	APPROVAL	吕海涛	2016.06.15
ECN NO.	REV.	DESCRIPTION	DATE	CHANGE			