

ROCKER

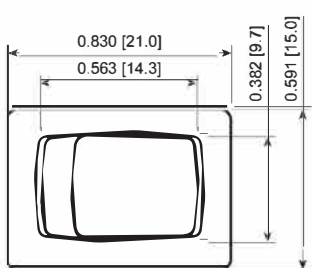

### Panel Cutout

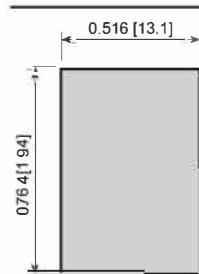

### Actuator Options

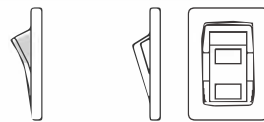

Bi-Color

Customizable

### Terminal Options

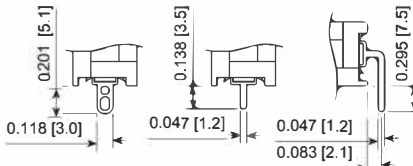

Solder

Standard PCB

Horizontal PCB

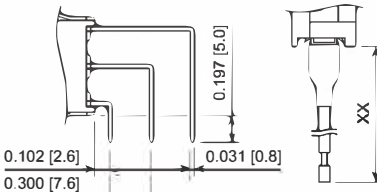
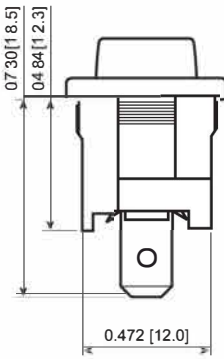
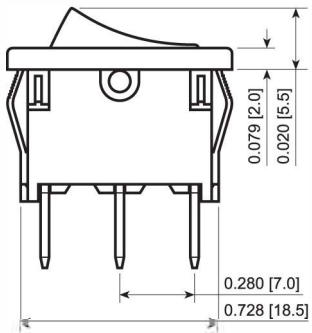

Vertical PCB

Wire Leads

### Water Protection Option

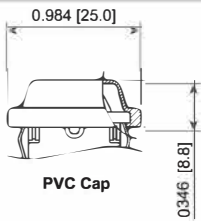

### Illumination Options

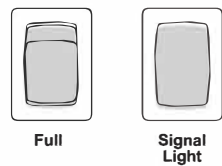

Full

Signal Light

Dimensions of Illuminated Switches May Vary From Above

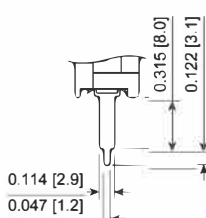

Extended PCB

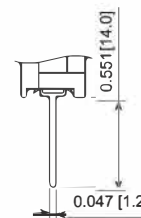

Wire Wrap



RA111C1A00



RA111C1021-116



RA111C1213



RA113C1100  
ACC-P01

Series	Terminal	Function	Rating	Body Color	Actuator Color	Marking Color	Marking Type	Lens Style	Lens Color	Lamp Voltage
RA1 - Curved Actuator	0 - Blank	0 - Signal / Blank	0 - Signal / Blank	1 - Black	0 - Illuminated	0 - None	0 - None	1 - Full / Signal	0 - Clear	3 - 6V
RA1C - Customizable Actuator	1 - 4.8mm Tab (*)	1 - Off(On *)	1 - Off(On *)	2 - White	1 - Black	1 - Black	1 - I/O Vert.	1 - Red	1 - Red	4 - 12V
	2 - Solder (*)	2 - On-Off	2 - On-Off	3 - Almond	2 - White	2 - White	2 - ON/OFF/ON Vert.	2 - Amber	2 - Amber	6 - 125V
	3 - PCB Pin	3 - On-On	3 - 11A 125V	4 - Grey	3 - Almond	8 - Red	3 - ON/OFF Vert.	3 - Green	3 - Green	7 - 250V
	H - Horiz. PCB	4 - Off.(On)	C - 16A 125V	9 - Red	4 - Grey		4 - ON/OFF Horiz.	4 - Blue	4 - Blue	
	V - Vert. PCB	5 - On-Off(On)			5 - Orange		5 - I/O/II Vert.	5 - Yellow	5 - Yellow	
	A14 - Wire Wrap	A - On-Off			7 - Blue		7 - I/O/III Vert.			
	E08 - Ext. PCB	C - On-Off-Off			8 - Green		8 - I/O/IV Vert.			
	Wxx - Wire Leads	D - (On)-Off-(On)			9 - Red		9 - I/O/V Vert.			
		(xx in Inches)					R - I/O Horiz.			

Notes:  
Not All Combinations are Available. Please Check with Sales  
\* = Options Available with Illuminated Switches

BiColor:  
A - Black / Red  
B - Black / White  
C - White / Red

Custom Colors and Markings Available Upon Request

For Illuminated Switches Only

### EXAMPLE PART NUMBERS:

- RA11131100 1P Off-On  
Black Body/Actuator, No Marking
- RA11131121 1P Off-On  
Black Body/Actuator, I/O Vert.
- RA111C1100 1P Off-On  
Black Body/Actuator, No Marking
- RA111C1121 1P Off-On  
Black Body/Actuator, I/O Vert.
- RA111C1021-116 1P Off-On  
Red Illum. Actuator, Black Body, I/O Vert.
- RA11331100 1P On-On  
Black Body/Actuator, No Marking
- RA11531100 1P On-Off-On  
Black Body/Actuator, No Marking
- RA11531122 1P On-Off-On  
Black Body/Actuator, ON/OFF/ON Vert.
- RA13131100 1P Off-On  
Black Body/Actuator, PCB Pins, No Marking
- RA1H331100 1P On-On  
Black Body/Actuator, Right Angle PCB Pins