

R6 SERIES ROCKER SWITCH

ANTI-VANDAL SWITCHES
 DETECTOR SWITCHES
 DIP SWITCHES
 KEYLOCK SWITCHES
 NAVIGATION SWITCHES
 PUSHBUTTON SWITCHES
ROCKER SWITCHES
 ROTARY SWITCHES
 SLIDE SWITCHES
 SNAP ACTION SWITCHES
 TACTILE SWITCHES
 TOGGLE SWITCHES
 CAP OPTIONS

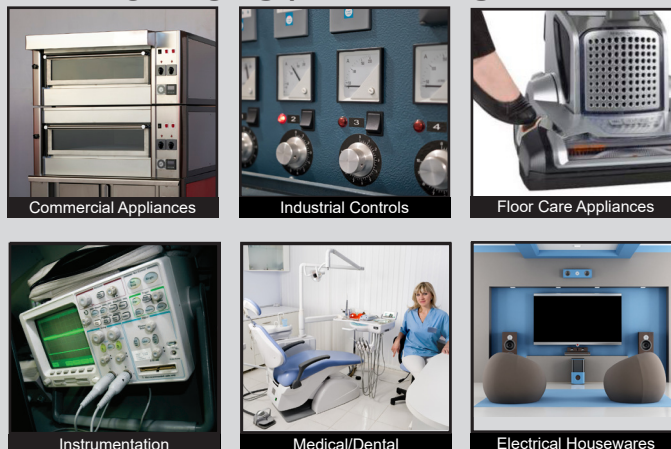

APPLICATIONS / MARKETS



RoHS

SPECIFICATIONS

Electrical Rating: 10A 125VAC [UL, cUL]
 6A 250VAC [UL, cUL]
Mechanical Life: 30,000 Cycles
Electrical Life: 10,000 Cycles
Contact Resistance: < 20mΩ (Initial)
Insulation Resistance: > 1,000MΩ at 500VDC
Dielectric Strength: > 1,500VAC for 1 Minute (Initial)
Operating Temperature: -20°C to 65°C
Storage Temperature: -30°C to 80°C
Panel Thickness: 0.75 - 3.00mm

FEATURES & BENEFITS

- Slim-line package design
- Maintained and momentary functions

PART NUMBER CONFIGURATOR

Series	Function	Housing Color	Actuator Color	Marking	Termination
<input type="text" value="R"/> <input type="text" value="6"/>	<input type="text" value="A"/> <input type="text" value="B"/>	<input type="text" value="BLK"/> <input type="text" value="GRY"/>	<input type="text" value="BLK"/> <input type="text" value="RED"/> <input type="text" value="GRY"/>	<input type="text" value="A"/> <input type="text" value="E"/> <input type="text" value="F"/>	<input type="text" value="F"/>
R6	A - SPST On - Off B - SPST (On) - Off	BLK - Black GRY - Grey	BLK - Black RED - Red GRY - Grey	A - Dot E - Blank F - I/O Vertical	F - Faston

NOTES:
 () denotes function is momentary

Specifications subject to change without notice 11.16.2021

R6 SERIES ROCKER SWITCH

BODY DIMENSIONS

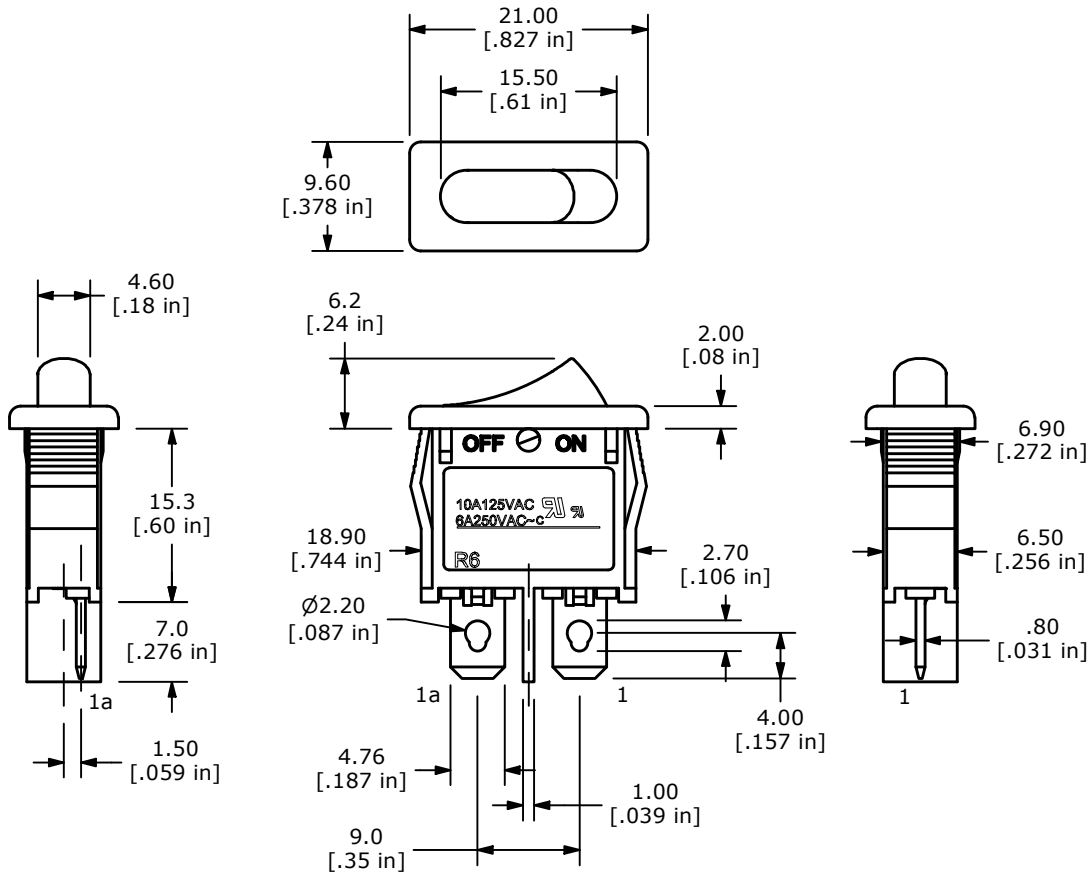
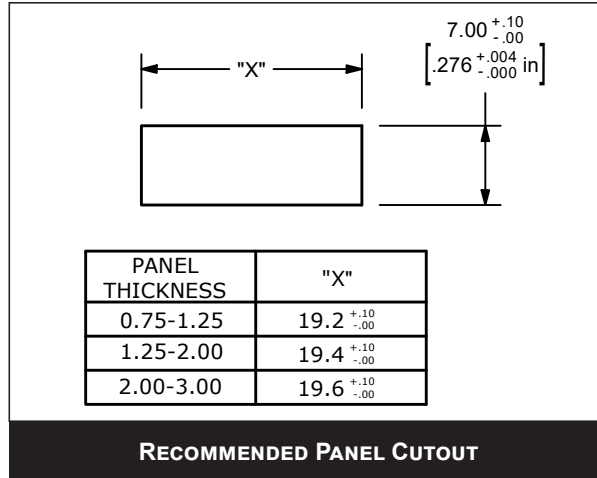
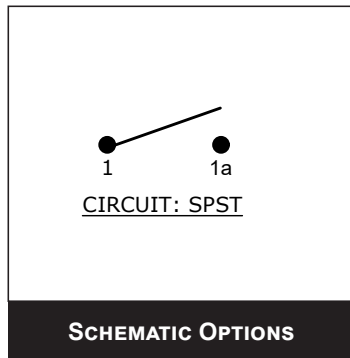

MARKING OPTIONS

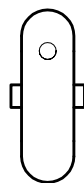

A - DOT

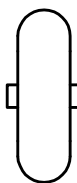

E - BLANK

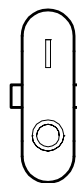

F - I/O VERTICAL