

RA4 Series

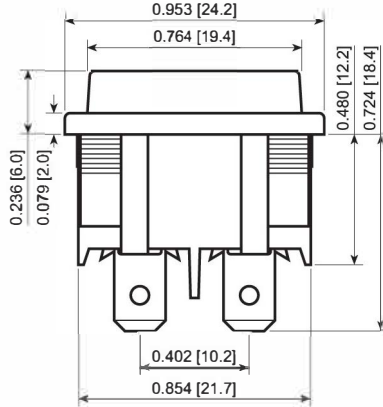

ROCKER

Panel Cutout

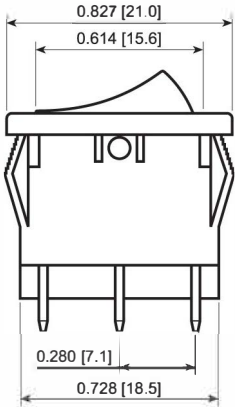
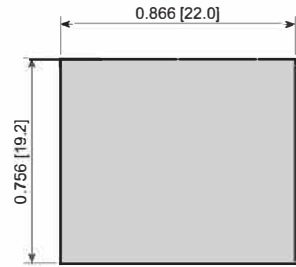
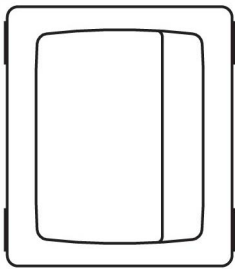

Actuator Options

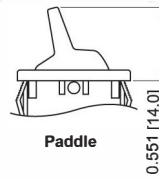

Paddle

Illumination Options

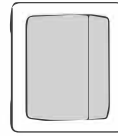

Full

Water Protection Options

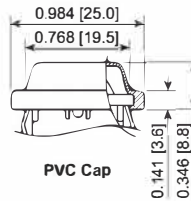

PVC Cap

FEATURES:

- High Rating with UL Approval
- Curved and Paddle Actuator Options
- PVC Cap for Dust and Water Protection

SPECIFICATIONS:

RATING: RATING OPTION C:
 16A 125VAC [UL, cUL]
 10A 250VAC [UL, cUL]
 1/3HP 125/250VAC 105°C [UL, cUL]

RATING OPTION 3:
 10A 125VAC [UL, cUL]

TEMPERATURE: -20°C to 105°C [UL, cUL]

ELECTRICAL LIFE: 10,000 Cycles
 CONTACT RESISTANCE: 35mΩ Max.
 INSULATION RESISTANCE: 100MΩ Min. at 500VDC
 DIELECTRIC STRENGTH: 1,500VAC for 1 Minute
 INGRESS PROTECTION: IP54 with PVC Cap

Terminal Options

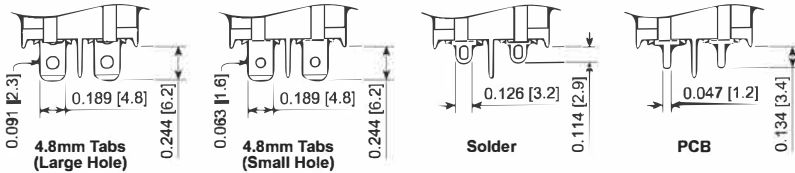

RAP41232200



RA41231121



RA42631100



RA41231188

Series	Terminal	Function	Rating	Body Color	Actuator Color	Marking Color	Marking Type	Lens Style	Lens Color	Lamp Voltage
<input type="checkbox"/> RA4 - Curved Actuator <input type="checkbox"/> RA4P - Paddle Actuator	<input type="checkbox"/> 1 - 4.8mm Tab (Small Hole) <input type="checkbox"/> 3 - PCB <input type="checkbox"/> 5 - Solder <input type="checkbox"/> 8 - 4.8mm Tab (Large Hole)	1 Pole: 1 - Off-On 3 - On-On 4 - Off-(On) 5 - On-Off-On A - On-(Off) B - On-(On) 2 Pole: 2 - Off-On (*) G - On-On E - Off-(On) 6 - On-Off-On F - On-(Off) H - On-(On)	3 - 10A 125VAC C - 16A 125VAC	1 - Black 2 - White 3 - Almond 4 - Grey	1 - Black 2 - White 3 - Almond 4 - Grey 5 - Orange 7 - Blue 8 - Green 9 - Red	0 - None 1 - Black 2 - White 8 - Red	0 - None 1 - I/O Vert. 2 - ON/OFF/I/O Vert. 3 - ON/OFF Vert. 4 - ON/OFF Horiz. 9 - I/O/II Horiz. S - I/O/II Vert. R - I/O Horiz.	1 - Full	0 - Clear 1 - Red 2 - Amber 3 - Green 4 - Blue	3 - 6V 4 - 12V 6 - 125V 7 - 250V

Note:
 * = Option Available with Illumination

Custom Colors and Markings Available Upon Request For Illuminated Switches Only

EXAMPLE PART NUMBERS:
 RA412C1100 2P Off-On
 Black Body/Actuator, 4.8mm Tab, No Marking
 RA412C1121 2P Off-On
 Black Body/Actuator, 4.8mm Tab, I/O Vert.