



KSD

SWITCH CONNECTOR



SPECIFICATIONS

RATING : 16A, 26A 250/125VAC.
CONTACT RESISTANCE : 50 mΩ max. @ 1A 12VDC (initial value)
INSULATION RESISTANCE : 100 MΩ min. at 500VDC
DIELECTRIC STRENGTH : 1,500V RMS @ sea level (initial value)
OPERATION TEMPERATURE : -25°C to 85°C
MECHANICAL LIFE : Momentary 1,000,000 cycles
 Latching 500,000 cycles
ELECTRICAL LIFE : 16A /125 & 250VAC 50,000 cycles
 26A /125 & 250VAC 10,000 cycles
OPERATION PRESSURE : 3.5±1.5N
TRAVEL : About 3.2mm
INGRESS PROTECTION : IP67(In house test), IK08(Stainless)
TORQUE : 1~3Nm.

MATERIALS

BUSHING : Stainless Steel / Aluminum alloy
BASE : PBT(UL 94-V0) , PC(UL 94-V2)
ACTUATOR : PC ; Stainless Steel / Aluminum alloy
INNER ASSEMBLY : POM / PA66.
SPRING : Steel.
SEALING : Silicone.
O-Ring : Silicone.
TERMINAL: Brass, Silver plated.
HEX NUT : Nickel plated brass.

KSD-MW19
Pushbutton Switches

HOW TO ORDER

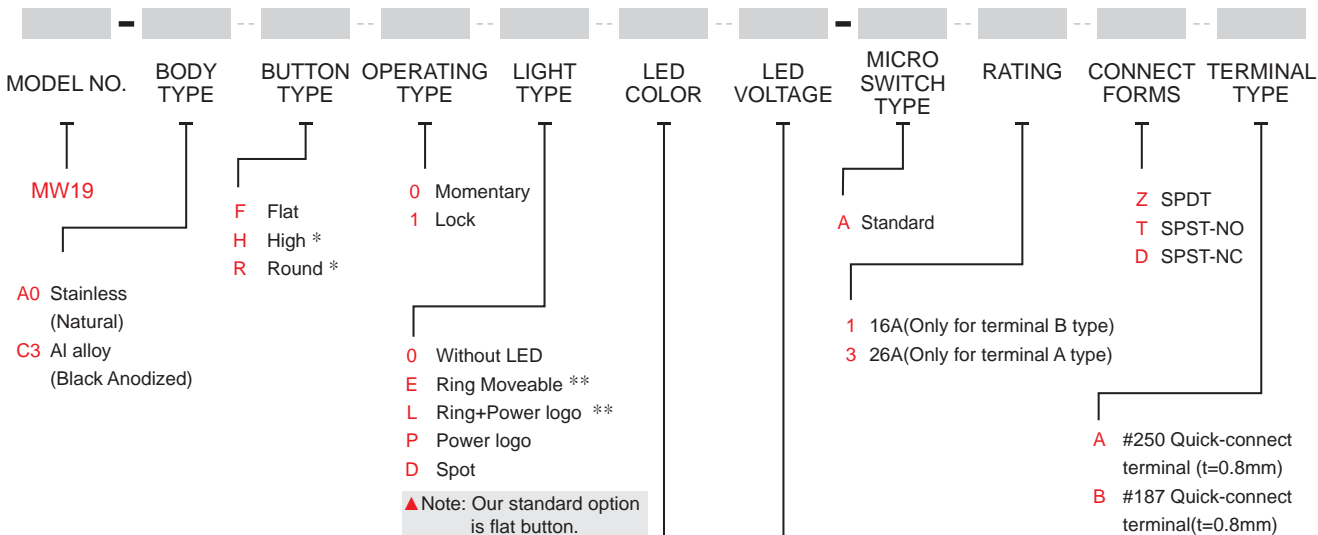

ITEM NO	COLOR
Single Color LED	
0	Without LED
1	White
3	Red
5	Yellow
6	Green
7	Blue
Dual Color LED	
A	Red+Green
B	Red+Blue

LED Voltage (20mA)

ITEM NO	VOLTAGE
0	Without Resistor
3	3V
6	6V
12	12V
24	24V
36	36V
110	110V
220	220V

* Standard is without LED and only available with A0 body type.
 ** For button type F only.
 *** Except standard color, for other colors information please consult sales representativity.

EXAMPLE:

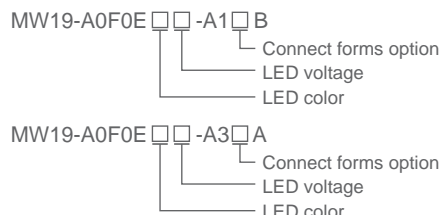



KSD-MW19 Series

19mm High Current Metal Pushbutton Switches



KSD-MW19
Pushbutton Switches

▼ BODY OPTIONS

A0 / C3

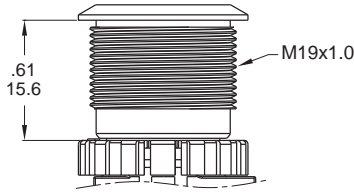

PANEL MOUNTING

Max. Panel thickness: .394inch(10.0mm)

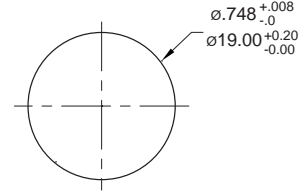

▼ BUTTON OPTIONS

F Flat (std)

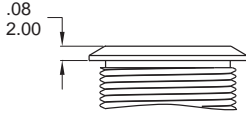

H High, No LED

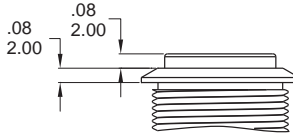

Standard for A0 body type .

R Round, No LED

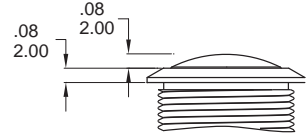

Standard for A0 body type .

▼ LIGHT OPTIONS

O Without LED

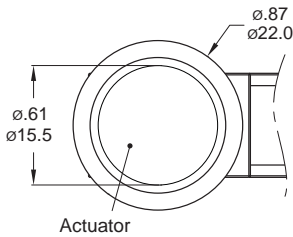

E Ring Moveable

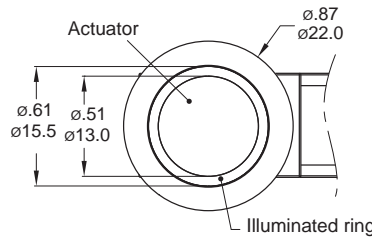

Available with flat button only.

D Spot

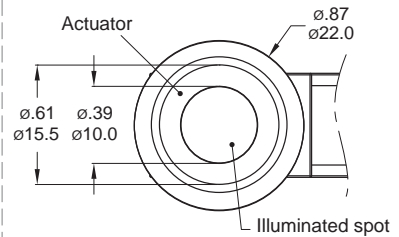

P Power logo *

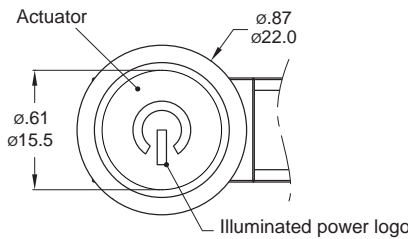

L Ring+Power logo *

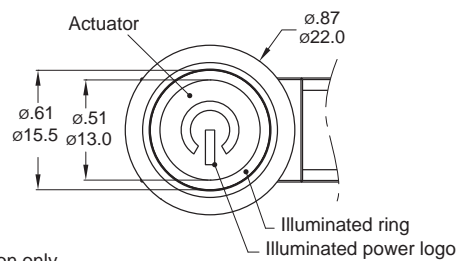

* Available with flat button only.

▼ TERMINAL OPTIONS

#187 Only 16A

Quick-connect terminal(t=0.3inch(0.8mm))

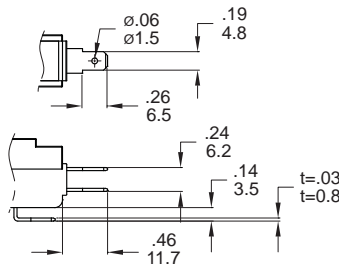

#250 Only 26A

Quick-connect terminal(t=0.3inch(0.8mm))

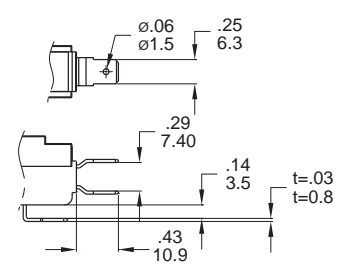

▼ CIRCUIT

SPDT

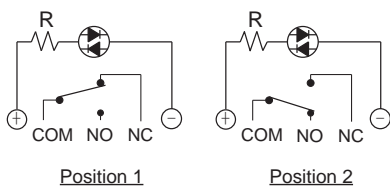

SPST-NO

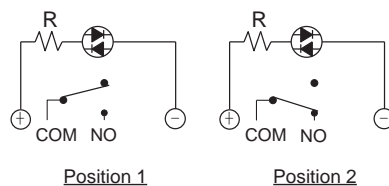

SPST-NC

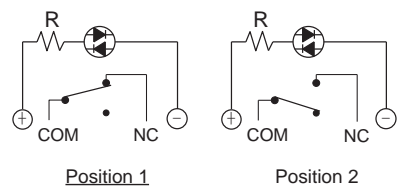

MW 安裝說明

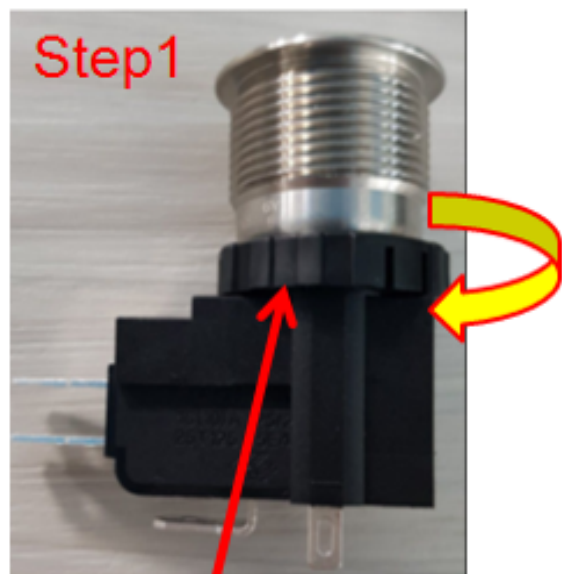

向左旋轉

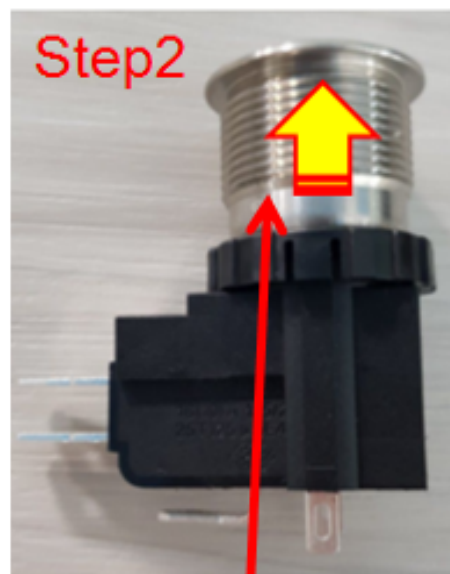

向上取出



安裝上半部



安裝下半部



向右旋轉



※注意事項：
加線材使用時，LED正/負端子需以快接端子方式，以免無法安裝。

