

# KSD-ZMSM Series with Mounting Hole Mini Size Snap-acting Switches

## Features/Benefits

- Reliable snap-acting mechanism
- Long electrical and mechanical life
- Various PCB terminals & actuators
- RoHS compatible
- IP67 for standalone switch except the metal terminal part; Full IP67 protection when potted with wire version

## Typical Applications

- Communication devices
- Testing equipment
- Security/Alarm systems
- Automotive: door latch, seat position detection, EV charging

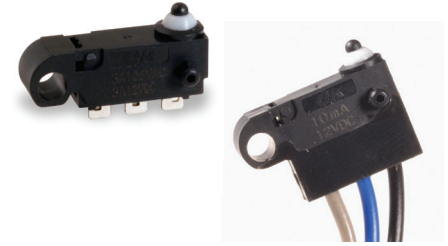

UL61058-1

## Specifications

CONTACT RATING: 3A@ 125 V AC/ 3A@ 12 V DC, 0.01 A@ 12 V DC.  
 ELECTRICAL LIFE: 100,000 cycles @ 0.01 A, 12 V DC / 100,000 cycles @ 3A, 12 V DC, 6,000 cycles @ 3A, 125 VAC  
 INSULATION RESISTANCE: 100 M ohm min.  
 DIELECTRIC STRENGTH: 500 Vrms.  
 OPERATING TEMPERATURE: -40°C + 85°C.  
 OPERATING FORCE: 130 grams.

\* Low Level=conditions where no arcing occurs during switching, i.e., 0.4 VA max. @ 20 V AC or DC max.

## Materials

CASE: Nylon  
 COVER/ACTUATOR: PBT  
 MOVABLE CONTACTS: 3 Amp silver, 0.01A gold  
 STATIONARY CONTACTS: 3 Amp silver, 0.01A gold  
 TERMINALS: Brass, Pre-plated with silver  
 LEVER: Stainless steel

**NOTE:** Specifications and materials listed above are for switches with standard option. For information on specific and custom switches, consult Customer Service Center.

Sealing cap could possibly be damaged in case of contacts with oils or greases. Please try to avoid direct contact. If more support is needed, consult Customer Service Centre.

## Build-A-Switch

To order, simply select desired option from each category and place in the appropriate box. For additional options not shown in catalog, consult Customer Service Center.

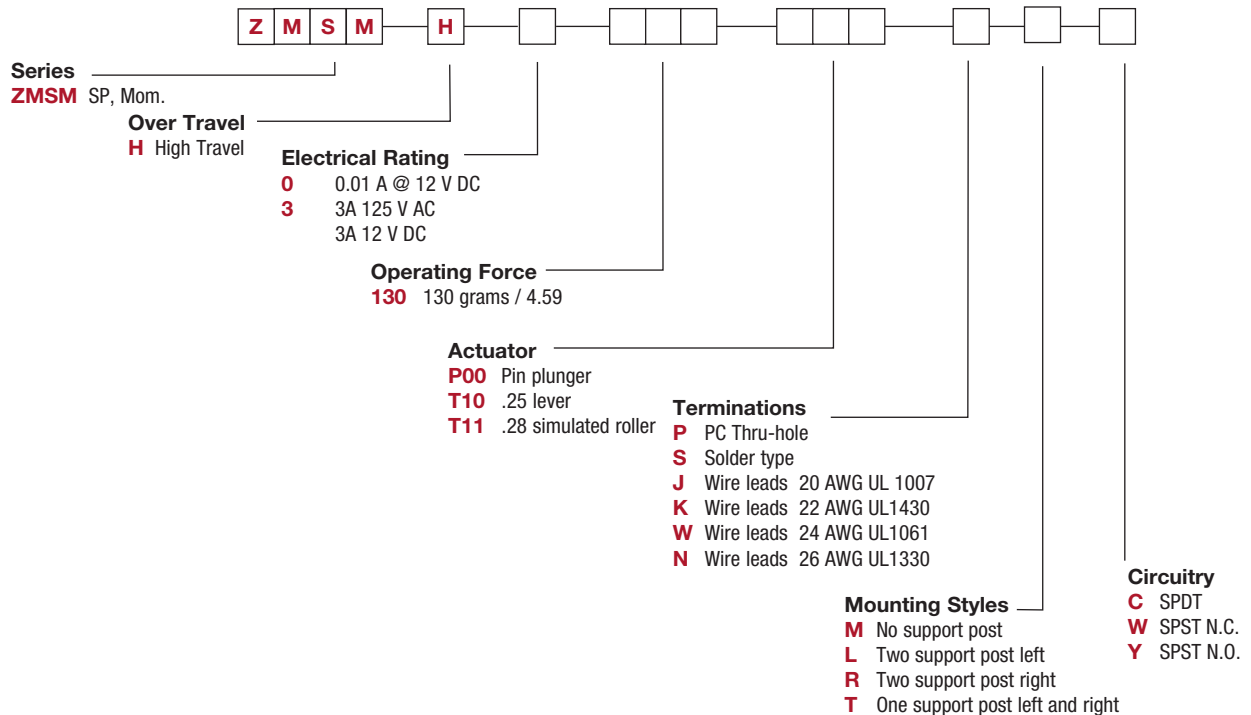

Dimensions are shown: Inch (mm)  
 Specifications and dimensions subject to change

### SERIES

**ZMSMH** HIGH OVER TRAVEL

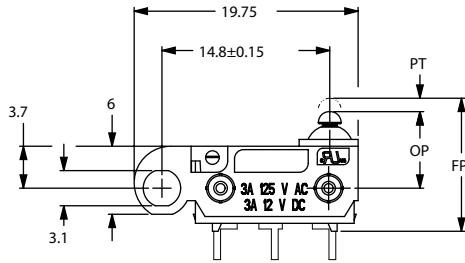
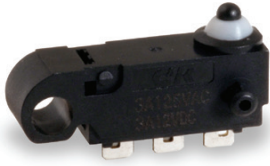

MODEL SHOWN: ZMSMHXXXP00PLC

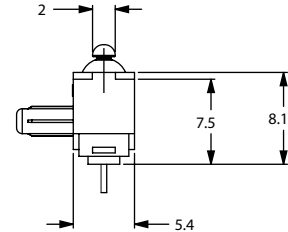

### ELECTRICAL RATING

OPTION CODE	RoHS COMPLIANT*	RoHS COMPATIBLE*	CONTACT MATERIAL		ELECTRICAL RATING
			MOVABLE CONTACT	STATIONARY CONTACT	
<b>0</b>	Yes	Yes	Gold alloy		0.01 A @ 12 V DC
<b>3</b>	Yes	Yes	Silver alloy		3 AMPS @ 125 V AC 3 AMPS @ 12 V DC

Model **CRUS** with option "S" (solder type) only.  
Consult Customer Service center for availability and delivery of nonstandard ratings.

### OPERATING FORCE

OPTION CODE	BASIC SWITCH OPERATING FORCE (OZ./GRAMS)
<b>130</b>	130 4.59

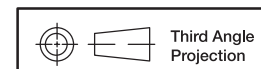

Dimensions are shown: Inches (mm)  
Specifications and dimensions subject to change

# KSD-ZMSM Series with Mounting Hole Mini Size Snap-acting Switches



## ACTUATOR

### P00 PIN PLUNGER (IP65)

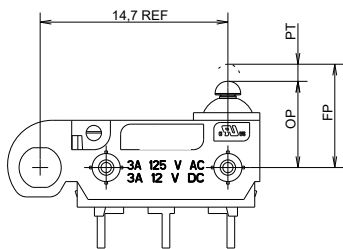

MODEL SHOWN: ZMSMHXXXXP00PLC

### T10 .25 LEVER (IP65)

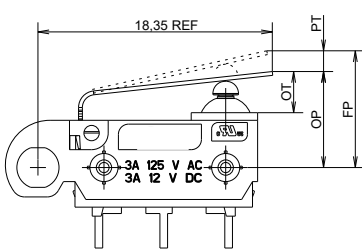

MODEL SHOWN: ZMSMHXXXXT10PLC

### T11 LEVER (IP65)

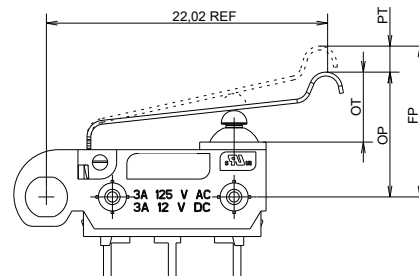

MODEL SHOWN: ZMSMHXXXXT11PLC

### SWITCH CHARACTERISTICS

Actuator code	Maximum Operate Force (grams/oz.)	Minimum Release Force (grams/oz.)	Free Position Max (mm)	Maximum Pre-travel (mm)	Operate Position (mm)	Maximum Differential (mm)	Overtravel min. (mm)
P00	130 4.59	13 0.45	7.35	0.8	6.75 ± 0.3	0.3	1.75
T10	195 6.88	55 1.93	10.70	3.85	7.40 ± 0.8	0.5	2.3
T11	160 5.64	45 1.58	13.80	4.8	9.90 ± 0.8	0.7	2.6

## TERMINATIONS

### P PC THRU-HOLE (IP65)

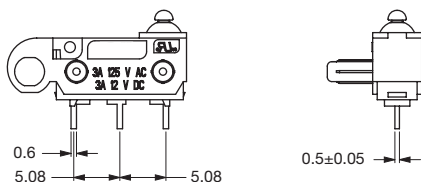

MODEL SHOWN: ZMSMHXXXXP00PLC

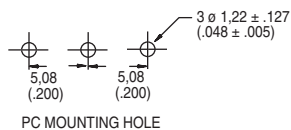

PC MOUNTING HOLE

### S SOLDER TYPE (IP65)



MODEL SHOWN: ZMSMHXXXXP00SMC

### J, K, W, N WIRE LEADS BOTTOM (IP67)

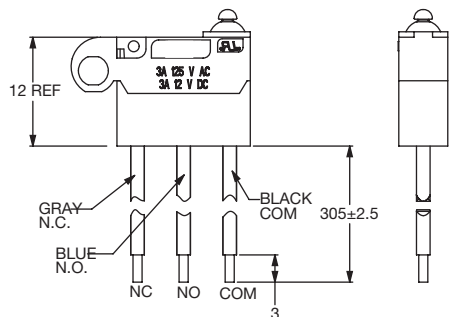

Standard Wire: 20 AWG UL 1007

Available options - must specify

**J** - 20AWG UL1007 (Standard)

**K** - 22AWG UL1430

**W** - 24AWG UL1061

**N** - 26AWG UL1330



Dimensions are shown: Inch (mm)

Specifications and dimensions subject to change

### MOUNTING STYLES

#### M NO SUPPORT POSTS

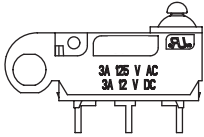
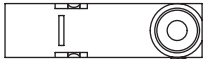

MODEL SHOWN:  
ZMSMHXXXXP00PMC

#### L TWO SUPPORT POSTS LEFT

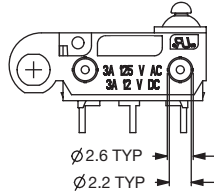
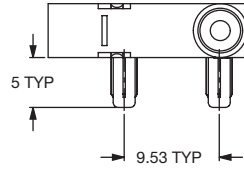

POSTS LEFT  
MODEL SHOWN:  
ZMSMHXXXXP00PLC

#### R TWO SUPPORT POSTS RIGHT

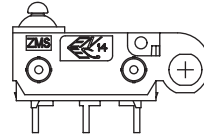
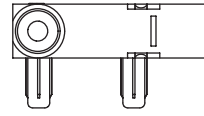

POSTS RIGHT  
MODEL SHOWN:  
ZMSMHXXXXP00PRC

#### T ONE SUPPORT POST LEFT & RIGHT

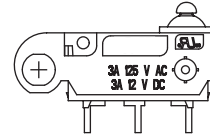
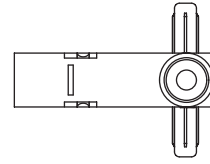

LEFT & RIGHT  
MODEL SHOWN:  
ZMSMHXXXXP00PTC

### CIRCUITRY

- C** SPDT (Single Pole, Double Throw)
- W** SPST, NC (Single Pole, Single Throw, Normally Closed)
- Y** SPST, NO (Single Pole, Single Throw, Normally Open)



Snap-acting

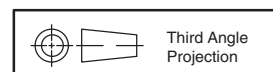

Third Angle  
Projection

Dimensions are shown: Inches (mm)  
Specifications and dimensions subject to change