

audio
automotive
aerospace
communication devices
consumer appliances
consumer electronics
datacom
data storage
handheld devices
industrial
industrial equipment
instrumentation
medical
military
mobile phones
portable tools
pumps & motors
security alarms
telecom
test equipment
thermostatic controls

KSD

SWITCH CONNECTOR

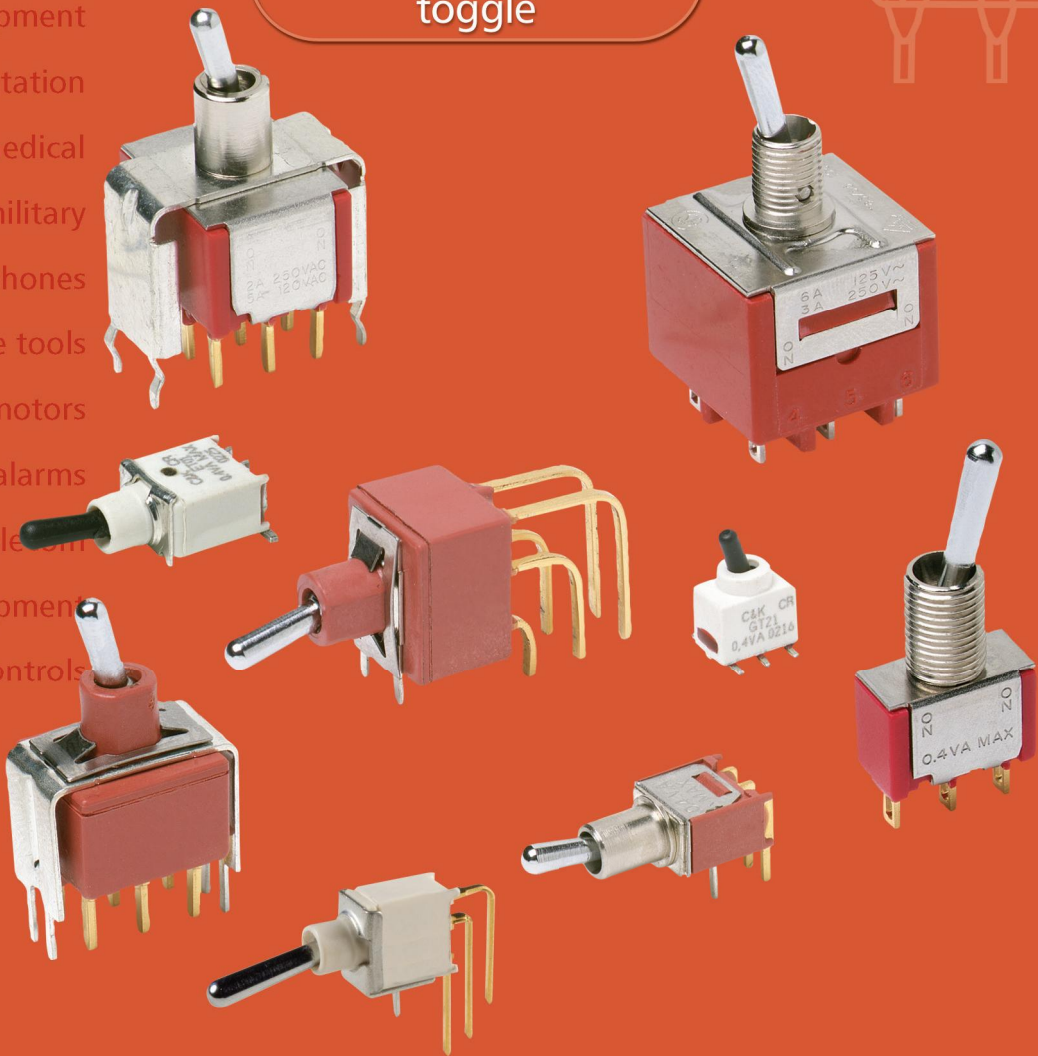

toggle

KSD

SWITCH CONNECTOR

KSD-9000 Series Power Toggle Switches

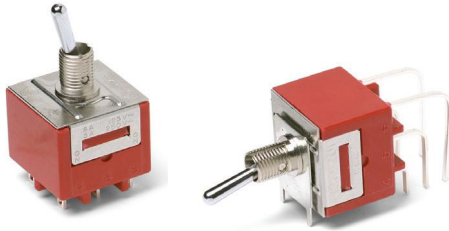

Features/Benefits

- Power ratings up to 10 AMPS
- Double pole models
- Locking lever options available
- Wide variety of actuator styles
- RoHS compliant and compatible

Typical Applications

- Shut-off switch
- Small equipment



UL 61058-1

Specifications

CONTACT RATING:

9201 Model

- GP (general purpose)
- 6 AMPS 125 VAC 50/60 Hz T85 10,000 cycles (10E3)
- 3 AMPS 250 VAC 50/60 Hz T85 10,000 cycles
- R (resistive)
- 6 AMPS 30 VDC T85 10,000 cycles

9221 Model:

- GP (general purpose)
- 10 AMPS 125 VAC 50/60 Hz T85 10,000 cycles
- 5 AMPS 250 VAC 50/60 Hz T85 10,000 cycles
- R (resistive)
- 10 AMPS 30 VDC T85 10,000 cycles

ELECTRICAL LIFE: 25,000 make-and-break cycles at full load.

CONTACT RESISTANCE: Below 10 m Ω typ. initial @ 2-4 V DC, 100 mA.

INSULATION RESISTANCE: 10⁹ Ω min.

DIELECTRIC STRENGTH: 2,500 Vrms min. @ sea level.

OPERATING TEMPERATURE: -30°C to 85°C.

SOLDERABILITY: Per MIL-STD-202F method 208D, or EIA RS-186E method 9 (1 hour steam aging).

Materials

CASE: Diallyl phthalate (DAP) (UL 94V-0).

ACTUATOR: Brass, chrome plated.

BUSHING: Brass or zinc, nickel plated.

HOUSING: Stainless steel.

SWITCH SUPPORT: Brass or steel, matte-tin plated.

END CONTACTS: 9201 Model: Coin silver, silver plated.

9221 Model: Silver cadmium oxide.

CENTER CONTACTS: Copper alloy, silver plated

ALL TERMINALS: 9201 Model: Copper alloy, silver plated.

9221 Model: Copper alloy, matte-tin plated.

TERMINAL SEAL: Epoxy.

HARDWARE: Nut & Locking ring: Brass, nickel plated.

Lockwasher: Steel, nickel plated.

NOTE: Any models supplied with Q contact material are RoHS compliant and compatible.

NOTE: Specifications and materials listed above are for switches with standard options. For information on specific and custom switches, consult Customer Service Center.

Build-A-Switch

To order, simply select desired option from each category and place in the appropriate box. Available options are shown and described on pages F-49 thru F-52. For additional options not shown in catalog, consult Customer Service Center.

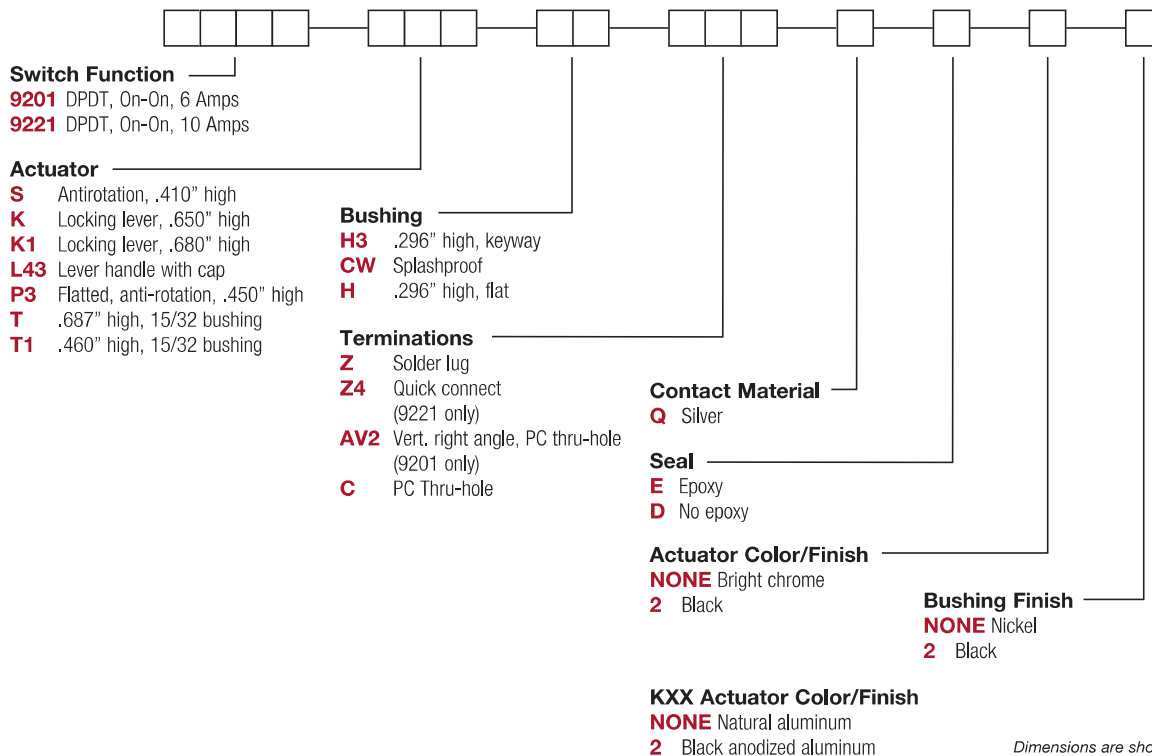

Dimensions are shown: Inches (mm)
Specifications and dimensions subject to change



F

Toggle

SWITCH FUNCTION

NO. POLES	MODEL NO.	RATING*	SWITCH FUNCTION		CONNECTED TERMINALS		SCHEMATIC
			POS. 1	POS. 2	POS. 1	POS. 2	
			KEYWAY	KEYWAY	KEYWAY	KEYWAY	
DP	9201	6 AMPS	ON	ON	2-3,5-6	2-1,5-4	
	9221	10 AMPS	ON	ON			

DPDT

Part number shown: 9201SH3ZQE

Terminal Nos. Molded On Side Of Case

* See CONTACT MATERIAL, page F-52, for complete ratings.

All 9000 Series models meet international dimensional and electrical requirements.



9221 model must be ordered with Z4 terminations and D seal option.

ACTUATOR

S ANTIROTATION, .410" HIGH

P3 FLATTED, ANTIROTATION, .450" HIGH

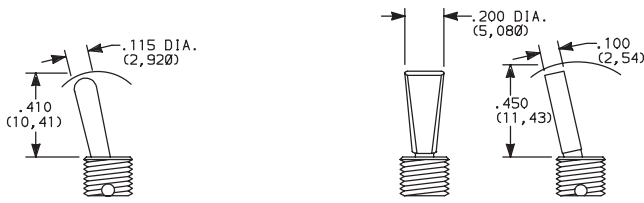

OPTION CODE	ACTUATOR FINISH
NONE	NATURAL ALUMINUM—With Nickel Plated Bushing
2	BLACK

NOTE: Black hardware is supplied when either black actuators or bushings are specified. All hardware is available separately, see Section N.

Antirotation is standard on all actuators, provides 'anti-push-in' feature on actuator.

Dress nut part number: 709901201 supplied standard with P3 actuator.

T .687" HIGH, 15/32 BUSHING

T1 .460" HIGH, 15/32 BUSHING

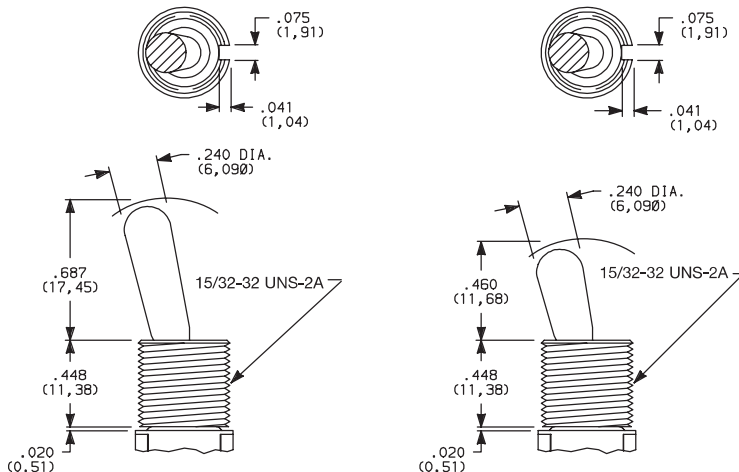

OPTION CODE	ACTUATOR FINISH
NONE	BRIGHT CHROME—With Nickel Plated Bushing
2	BLACK

NOTE: Bushing option code not required for T & T1 actuators unless CW splashproof bushing ordered.

Black hardware is supplied when either black actuators or bushings are specified. All hardware is available separately, see Section N.

Antirotation is standard on all actuators except T & T1, provides 'anti-push-in' feature on actuator.

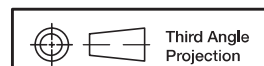

Dimensions are shown: Inches (mm)
Specifications and dimensions subject to change

KSD-9000 Series Power Toggle Switches



ACTUATOR FINISH

ACTUATOR

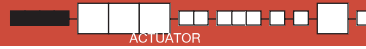

K LOCKING LEVER, .650" HIGH, THREADED

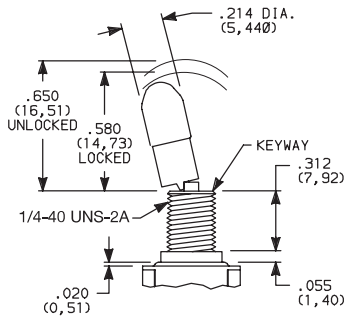

K1 LOCKING LEVER, .680" HIGH, THREADED

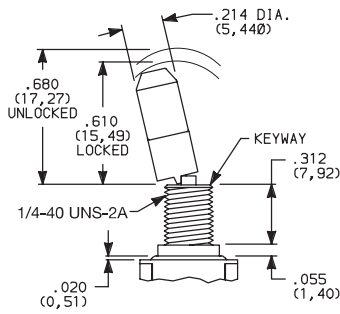

Locking Positions



2 Position Lock

NOTE: To prevent accidental actuation, toggles must be lifted before being actuated. When released, toggles again lock in place. Bushing option code not required. Overtightening mounting nut may cause actuator to bind.

OPTION CODE	ACTUATOR CAP FINISH
NONE	NATURAL ALUMINUM—With Nickel Plated Bushing
2	BLACK ANODIZED ALUMINUM

L40 LEVER HANDLE WITHOUT CAP

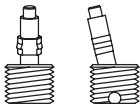

No color choice required.

L43 PLASTIC LEVER HANDLE WITH ANTIROTATION AND CAP, P/N 4812

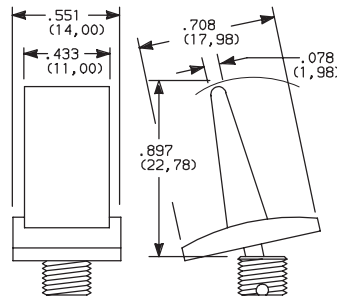

Finish: Matte

OPTION CODE	ACTUATOR CAP COLOR
2	BLACK
NONE	No Actuator Color (L40 option)

Other colors available, consult Customer Service Center.

NOTE: Lever handle actuator L43 supplied, but not installed. For interchangeability, order L40 actuator option and order lever handles separately, see page F-52. Antirotation is standard on all actuators, provides 'anti-push-in' feature.

BUSHING FINISH

BUSHING



H3 .296" HIGH, THREADED, KEYWAY

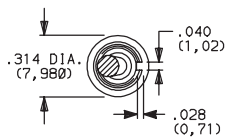

H .296" HIGH, THREADED, FLAT

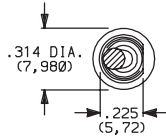

CW SPLASHPROOF, 15/32 BUSHING

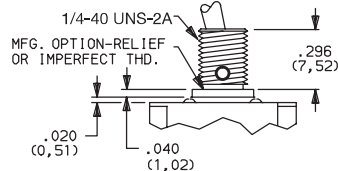
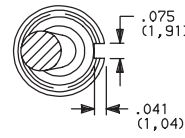

Will withstand 12 in./lbs. of torque with no distortion.

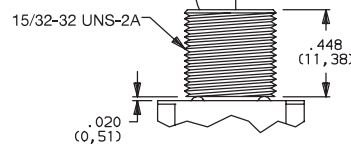
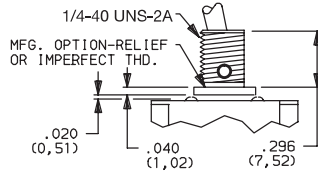

For T & T1 actuators only.

OPTION CODE	BUSHING FINISH
NONE	NICKEL
2	BLACK

NOTE: Two mounting nuts, locking ring and lockwasher supplied standard with threaded bushings. Black hardware is supplied when either black bushings or actuators are specified. Optional mounting nut and locking ring styles and finishes available, see Section N.

Internal actuator seal standard, External bushing seal available separately from APM Hexseal, part # MFS-60064.

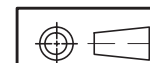

Third Angle Projection

Dimensions are shown: Inches (mm)
Specifications and dimensions subject to change

www.bodongkaiguan.net

BUSHING



PANEL MOUNTING

1/4-40 UNS-2A

15/32-32 UNS-2A

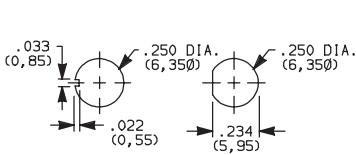

Without locking ring.

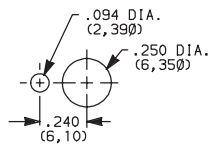

With standard locking ring.

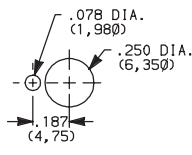

With small locking ring.

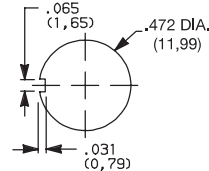

Without locking ring.

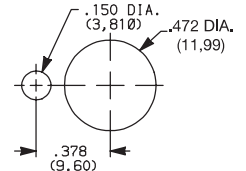

With standard locking ring.

TERMINATIONS



Z SOLDER LUG

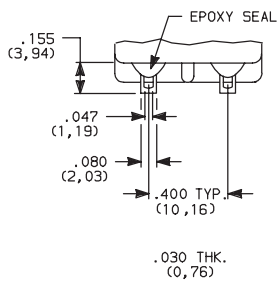

9201 Only

C PC THRU-HOLE

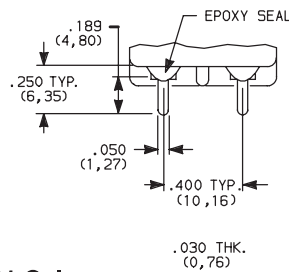

9201 Only

PC MOUNTING

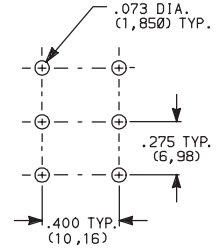

Z4 .187" QUICK CONNECT

9221 Only

NOTE: Only termination available with 9221 model. Must be ordered with D seal option. Mates with standard .187 Nema female connector.

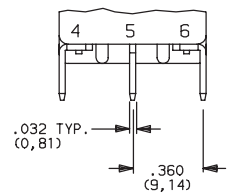
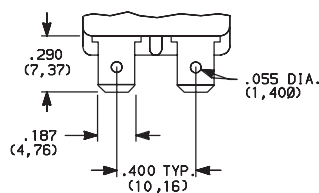

AV2 VERTICAL RIGHT ANGLE, PC THRU-HOLE

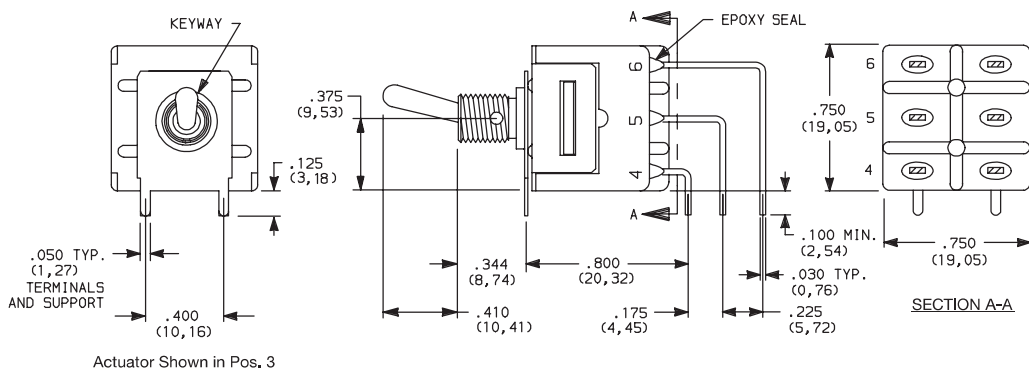

9201SH3AV2QE
Vertical Actuation
DPDT

Actuator Shown in Pos. 3

9201 Only

NOTE: Terminal bend radii and lead-in manufacturing option. Terminal spacing greater than 3mm at all points.

PC MOUNTING

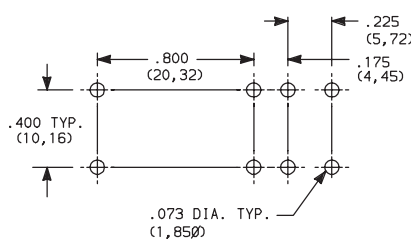

Terminal Nos.
For Reference Only



Third Angle
Projection

Dimensions are shown: Inches (mm)
Specifications and dimensions subject to change

www.bodongkaiguan.net



F

Toggle

KSD-9000 Series Power Toggle Switches



CONTACT MATERIAL

OPTION CODE	MODEL	CONTACT MATERIAL	TERMINAL PLATING	RATINGS
Q	9201	SILVER 1,2	SILVER OR TIN 2,5	GP (general purpose) 6 AMPS 125 VAC 50/60 Hz T85 10,000 cycles (10E3) 3 AMPS 250 VAC 50/60 Hz T85 10,000 cycles R (resistive) 6 AMPS 30 VDC T85 10,000 cycles
	9221	SILVER CADMIUM OXIDE 3,4,6	TIN 5	GP (general purpose) 10 AMPS 125 VAC 50/60 Hz T85 10,000 cycles 5 AMPS 250 VAC 50/60 Hz T85 10,000 cycles R (resistive) 10 AMPS 30 VDC T85 10,000 cycles

* Note: See Technical Data section of this catalog for RoHS compliant and compatible definitions and specifications.

1 END CONTACTS: Coin silver, silver plated.

2 CENTER CONTACTS & ALL TERMINALS: Copper alloy, silver plated.

3 END CONTACTS: Silver cadmium oxide.

4 CENTER CONTACTS: Copper alloy, silver plated.

5 Z4 TERMINALS ONLY: Copper alloy, matte-tin plated.

6 Cadmium in electrical switch contacts is exempt from RoHS.

NOTE: Any models supplied with Q contact material are RoHS compliant.

All 9000 Series models meet international dimensional and electrical requirements.

9221 model must be ordered with Z4 terminations and D seal option.



SEAL

E EPOXY SEAL

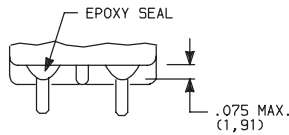

Not available with 9221 model or Z4 terminations.

D NO EPOXY SEAL

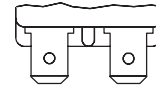

Must be ordered with 9221 model and Z4 termination.

AVAILABLE HARDWARE

Cap
Compatible with S actuator

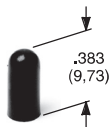

PART NO.
896801000 WHITE
896802000 BLACK
896803000 RED

Material: Polyethylene
Finish: Matte

Cap
Compatible with S actuator

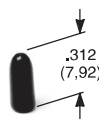

PART NO.
706201000 WHITE
706202000 BLACK
706203000 RED

Material: Vinyl
Finish: Matte

L43 Actuator

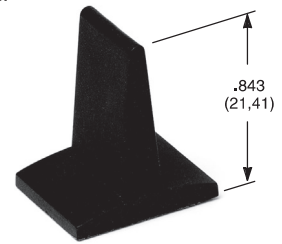

PART NO.
481202000 BLACK
481203000 RED

Material: Nylon
Finish: Matte

NOTE: Additional nuts, locking rings and lockwashers available separately, see Section N.

Other colors available, consult Customer Service Center.

759D02000 Sealing Boot

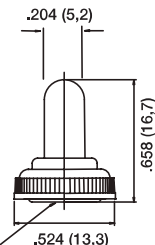

1/4-40 uns-2A nut

NOTE: For use with S actuator style when combined with H3 and H bushings

703D02000 Sealing Boot

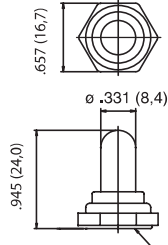

15/32-32 NS-2A

NOTE: For use with T style actuator

704D02000 Sealing Boot

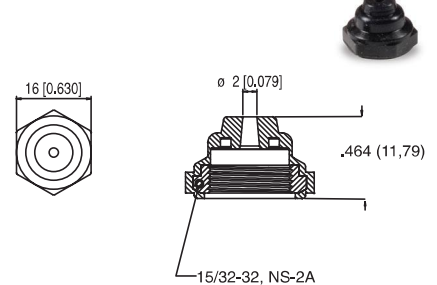

15/32-32, NS-2A

NOTE: For use with T style actuator

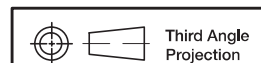

Third Angle Projection

Dimensions are shown: Inches (mm)
Specifications and dimensions subject to change

Toggle F

Toggle Switch Product Selection Guide

Toggles									
Series	7000	Military	E	ET	T	GT	9000	PT	ILT
Switch Type	Miniature	Miniature	Miniature	Subminiature	Subminiature	Ultraminiature	Power	Sealed power	Power
Poles/Throws	SPDT, DPDT, 3PDT, 4PDT	SPDT, DPDT	SPDT, DPDT, 3PDT	SPST, SPDT, DPDT	SPST, SPDT, DPDT	SPST, SPDT, DPST, DPDT	DPDT	SPST, DPST	SPST
Maximum Current Silver/Gold	5 Amps	5 Amps	7.5 Amps/ 5 Amps	3 Amps/ 2 Amps	3 Amps/ 2 Amps	0.4 VA	10 Amps	25 Amps	20 Amps
Process Sealed			•	•		•		•	
PCB Mount Options									
Vertical	•	•	•	•	•	•	•		
Right Angle	•	•	•	•	•	•			
Vertical Right Angle	•	•	•	•	•	•	•		
Surface Mount Options									
Vertical						•			
Right Angle				•		•			
Panel Mount Options									
Rear Mount	•	•	•		•		•	•	•
Termination Options									
PCB Thru-hole	•	•	•	•	•	•	•		
Wire Wrap	•		•	•	•				
Solder Lug	•	•	•		•		•	•	
Quick Connect	•		•				•	•	•
Other Available Options									
Support Brackets	•	•	•	•	•	•	•		•
Snap-in Retention	•		•	•					•
ESD Protection	•		•	•	•				•
Tape & Reel				•		•			
Bushing Options									
10-48					•				
1/4-40	•	•	•		•		•		
15/32	•						•	•	
M6P 0.75 (Metric)	•								
Page No.	F-3	F-17	F-22	F-30	F-37	F-43	F-50	F-55	F-59

