

audio  
automotive  
aerospace  
communication devices  
consumer appliances  
consumer electronics  
datacom  
data storage  
handheld devices  
industrial  
industrial equipment  
instrumentation  
medical  
military  
mobile phones  
portable tools  
pumps & motors  
security alarms  
telecom  
test equipment  
thermostatic controls

# KSD

SWITCH CONNECTOR

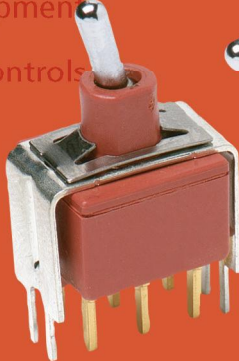

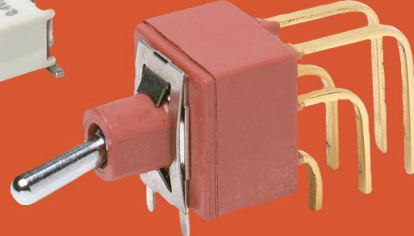
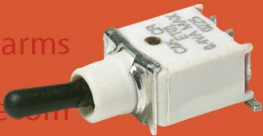
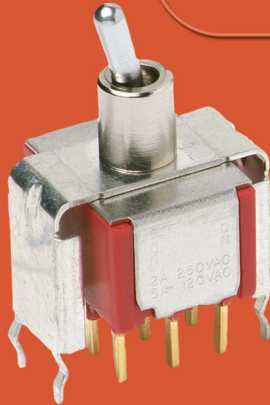

# toggle

# KSD

SWITCH CONNECTOR

# Toggle Switch Product Selection Guide

<b>Toggles</b>									
<b>Series</b>	<b>7000</b>	<b>Military</b>	<b>E</b>	<b>ET</b>	<b>T</b>	<b>GT</b>	<b>9000</b>	<b>PT</b>	<b>ILT</b>
<b>Switch Type</b>	Miniature	Miniature	Miniature	Subminiature	Subminiature	Ultraminiature	Power	Sealed power	Power
<b>Poles/Throws</b>	SPDT, DPDT, 3PDT, 4PDT	SPDT, DPDT	SPDT, DPDT, 3PDT	SPST, SPDT, DPDT	SPST, SPDT, DPDT	SPST, SPDT, DPST, DPDT	DPDT	SPST, DPST	SPST
<b>Maximum Current Silver/Gold</b>	5 Amps	5 Amps	7.5 Amps/ 5 Amps	3 Amps/ 2 Amps	3 Amps/ 2 Amps	0.4 VA	10 Amps	25 Amps	20 Amps
<b>Process Sealed</b>			•	•		•		•	
<b>PCB Mount Options</b>									
Vertical	•	•	•	•	•	•	•		
Right Angle	•	•	•	•	•	•			
Vertical Right Angle	•	•	•	•	•	•	•		
<b>Surface Mount Options</b>									
Vertical						•			
Right Angle				•		•			
<b>Panel Mount Options</b>									
Rear Mount	•	•	•		•		•	•	•
<b>Termination Options</b>									
PCB Thru-hole	•	•	•	•	•	•	•		
Wire Wrap	•		•	•	•				
Solder Lug	•	•	•		•		•	•	
Quick Connect	•		•				•	•	•
<b>Other Available Options</b>									
Support Brackets	•	•	•	•	•	•	•		•
Snap-in Retention	•		•	•					•
ESD Protection	•		•	•	•				•
Tape & Reel				•		•			
<b>Bushing Options</b>									
10-48					•				
1/4-40	•	•	•		•		•		
15/32	•						•	•	
M6P 0.75 (Metric)	•								
<b>Page No.</b>	F-3	F-17	F-22	F-30	F-37	F-43	F-50	F-55	F-59



F

Toggle

## Features/Benefits

- Multi-pole and multi-position
- Wide variety of actuator and termination options
- Epoxy terminal-seal compatible with bottom wash cleaning
- RoHS compliant models available

## Typical Applications

- Telecommunications
- Instrumentation
- Medical equipment

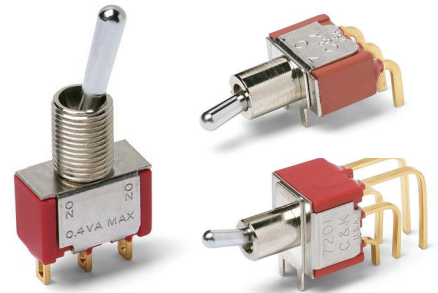

## Specifications

CONTACT RATING: B contact material: 0.4 VA max. @ 20 V AC or DC max. Q contact material: 5 AMPS @ 120 V AC or 28 V DC; 2 AMPS @ 250 V AC. See page F-15 for additional ratings.

ELECTRICAL LIFE: 7X01 and UX1 models: 100,000 make-and-break cycles at full load. All other models: 40,000 cycles.

CONTACT RESISTANCE: Below 10 m Ω typ. initial @ 2-4 V DC, 100 mA, for both silver and gold plated contacts.

INSULATION RESISTANCE: 10<sup>9</sup> Ω min.

DIELECTRIC STRENGTH: 1000 Vrms min. @ sea level.

OPERATING TEMPERATURE: -30°C to 85°C.

SOLDERABILITY: Per MIL-STD-202F method 208D, or EIA RS-186E method 9 (1 hour steam aging).

For materials see page F-5.

**NOTE:** Any models supplied with P, S, R, Q, B or G contact material are RoHS compliant and compatible.

**NOTE:** Specifications listed above are for switches with standard options. For information on specific and custom switches, consult Customer Service Center.

## Build-A-Switch

To order, simply select desired option from each category and place in the appropriate box. Available options are shown and described on pages F-5 thru F-17. For additional options not shown in catalog, consult our Customer Service Center.



### Switch Function

- 7101** SP On-None-On
- 7103** SP On-Off-On
- 7105** SP Mom.-Off-Mom.
- 7107** SP On-Off-Mom.
- 7108** SP On-None-Mom.
- 7109** SP None-On-Mom.
- 7201** DP On-None-On
- 7203** DP On-Off-On
- 7205** DP Mom.-Off-Mom.
- 7207** DP On-Off-Mom.
- 7208** DP On-None-Mom.
- 7211** DP On-On-On
- 7213** DP On-On-Mom.
- 7215** DP Mom.-On-Mom.
- 7301** 3P On-None-On
- 7303** 3P On-Off-On
- 7305** 3P Mom.-Off-Mom.
- 7308** 3P On-None-Mom.
- 7401** 4P On-None-On
- 7403** 4P On-Off-On
- 7405** 4P Mom.-Off-Mom.
- 7408** 4P On-None-Mom.
- 7411** 4P On-On-On
- 7413** 4P On-On-Mom.
- 7415** 4P Mom.-On-Mom.

**Note:** UL models available, see pages F-4 & F-5.

### Actuator

- M** .200" high
- P3** Flatted, anti-rotation, .450" high
- S** .420" high
- T** .687" high, 15/32 bushing
- K2** Locking lever, .704" high
- K9** Locking lever, .704" high
- K12** Locking lever, .732" high
- K19** Locking lever, .732" high
- L** .840" high
- L1** .640" high
- L1P** Anti-rotation, .640" high
- L2** .550" high
- L2P** Anti-rotation, .550" high
- L3** Plastic .940" inch
- L40** Lever handle without cap
- L41** .531" high lever handle with cap
- L42** .838" high lever handle with cap
- MP** Anti-rotation, .200" high
- P1** Flatted, anti-rotation, .840" high
- P4** Flatted, anti-rotation, .250" high
- SP** Anti-rotation, .420" high
- T1** .487" high, 15/32 bushing
- T1P** Anti-rotation, .487" high, 15/32 bushing
- T2P** Flatted, anti-rotation, .610" high, 15/32 bushing,
- TP** Anti-rotation, .687" high, 15/32 bushing

### Bushing

- D** .280 high, keyway
- H** .296 high, flat
- Y** .350 high, keyway
- NONE** No bushing choice required
- CW** Splashproof
- D8** .280" high, flat
- D9** .280" high, keyway
- H3** .315" high, keyway
- H4** 8mm high, keyway
- Y1** .378" high, keyway
- Y3** 8.9mm high, keyway
- Y4** .378" high, flat
- Y9** .350" high, keyway

### Terminations

- A** Right angle, PC thru-hole
- AV2** Vert. right angle, PC thru-hole
- C** PC Thru-hole
- V3** .460 high, V-bracket
- Z** Solder lug
- A2** Right angle, PC thru-hole
- A3** Right angle, PC thru-hole
- A4** Right angle, PC thru-hole
- AW1** Right angle, extended, PC thru-hole
- AW4** Right angle, extended, PC thru-hole
- V2** .555" high, V-bracket
- V4** .630" high, V-bracket
- V6** .460" high, V-bracket
- V7** .630" high, V-bracket
- V8** .953" high, V-bracket
- V9** 1.150" high, V-bracket
- V21** .555" high, snap-in V-bracket
- V31** .460" high, snap-in V-bracket
- V41** .630" high, snap-in V-bracket
- V71** .630" high, snap-in V-bracket
- V81** .953" high, snap-in V-bracket

### Contact Material

- B** Gold
- P** Gold, matte-tin
- Q** Silver
- S** Silver, matte-tin
- G** Gold over silver
- R** Gold over silver, matte-tin

### Seal

- E** Epoxy
- I** Epoxy potted base

### Actuator Color/Finish

- NONE** Bright chrome
- 2** Black
- 3** Red
- S** Satin chrome

### KXX Actuator Color/Finish

- NONE** Natural aluminum
- 2** Black anodized aluminum
- 3** Red anodized aluminum
- 7** Blue anodized aluminum
- G** Grip tip aluminum

### Bushing Finish

- NONE** Nickel on all bushings (except D8, satin chrome)
- 2** Black

- W** .750" long, wire wrap
- W1** .964" long, wire wrap
- W3** .425" long, wire wrap
- W4** 1.062" long, wire wrap
- W5** 1.305" long, wire wrap
- Z3** Quick connect

Dimensions are shown: mm  
Specifications and dimensions subject to change



# KSD-7000 Series Miniature Toggle Switches



## Materials

CASE: Glass filled nylon 6/6, flame retardant, heat stabilized, or diallyl phthalate (DAP) (UL 94V-0).

ACTUATOR: Brass, chrome plated.

BUSHING: Brass or zinc, nickel plated.

HOUSING: Stainless steel.

SWITCH SUPPORT: Brass or steel, tin plated.

END CONTACTS: B contact material: Copper alloy, with gold plate over nickel plate. Q contact material: Coin silver, silver plated. See page F-15 for additional contact materials.

CENTER CONTACTS & ALL TERMINALS: B contact material: Copper alloy, with gold plate over nickel plate. Q contact material: Copper alloy, silver plated. See above for additional contact materials.

TERMINAL SEAL: Epoxy.

HARDWARE: Nut & Locking Ring: Brass, nickel plated.

Lockwasher: Steel, nickel plated.

NOTE: Materials listed above are for switches with standard options. For information on specific and custom switches, consult Customer Service Center.

## SWITCH FUNCTION



NO. POLES	MODEL NO.	UL** MODEL NO.	SWITCH FUNCTION			CONNECTED TERMINALS			SCHEMATIC
			POS. 1	POS. 2	POS. 3	POS. 1	POS. 2	POS. 3	
			KEYWAY	KEYWAY	KEYWAY	KEYWAY	KEYWAY	KEYWAY	
SP	7101	U11	ON	NONE	ON	2-3	N/A	2-1	
	7103	U13	ON	OFF	ON	2-3	OPEN	2-1	
	7105	U15	MOM.	OFF	MOM.				
	7107	U17	ON	OFF	MOM.				
	7108	U18	ON	NONE	MOM.	2-3	N/A	2-1	
7109	U19	NONE	ON	MOM.	N/A	2-3	2-1	SPDT	

### SPDT

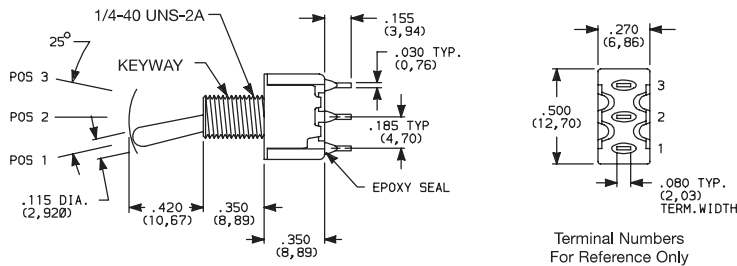

Part number shown: 7101SYZBE

DP	7201	U21	ON	NONE	ON	2-3,5-6	N/A	2-1,5-4	
	7203	U23	ON	OFF	ON	2-3,5-6	OPEN	2-1,5-4	
	7205	U25	MOM.	OFF	MOM.				
	7207	U27	ON	OFF	MOM.				
	7208	U28	ON	NONE	MOM.	2-3,5-6	N/A	2-1,5-4	
	7211 *	U211 *	ON	ON	ON	2-3,5-6	2-3,5-4	2-1,5-4	
	7213 *	U213 *	ON	ON	MOM.				
7215 *	U215 *	MOM.	ON	MOM.					

### DPDT

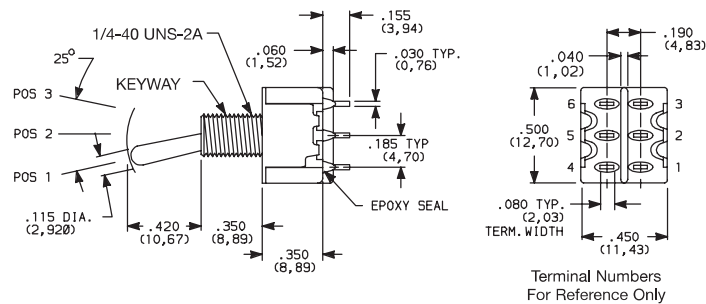

Part number shown: 7201SYZQE

MOM. = Momentary

\*\* Wiring for 3-way switch

\*\* U11-U415 model nos.



with all options when ordered with G, R, Q or S contact material.



Dimensions are shown: Inches (mm)

Specifications and dimensions subject to change

www.bodongkaiguan.net



F

Toggle

## SWITCH FUNCTION

NO. POLES	MODEL NO.	UL** MODEL NO.	SWITCH FUNCTION			CONNECTED TERMINALS			SCHEMATIC
			POS. 1	POS. 2	POS. 3	POS. 1	POS. 2	POS. 3	
			KEYWAY	KEYWAY	KEYWAY	KEYWAY	KEYWAY	KEYWAY	
3P	<b>7301</b>	<b>U31</b>	ON	NONE	ON	2-3,5-6,8-9	N/A	2-1,5-4,8-7	
	<b>7303</b>	<b>U33</b>	ON	OFF	ON	2-3,5-6,8-9	OPEN	2-1,5-4,8-7	
	<b>7305</b>	<b>U35</b>	MOM.	OFF	MOM.				
	<b>7307</b>	<b>U37</b>	ON	OFF	MOM.				
	<b>7308</b>	<b>U38</b>	ON	NONE	MOM.	2-3,5-6,8-9	N/A	2-1,5-4,8-7	

### 3PDT

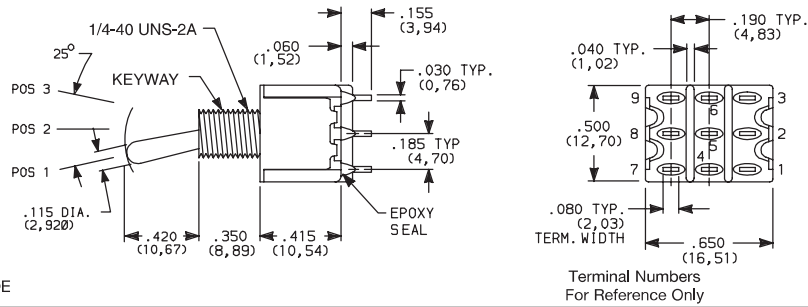

Part number shown: 7301SYZQE

Terminal Numbers  
For Reference Only

4P	<b>7401</b>	<b>U41</b>	ON	NONE	ON	2-3,5-6,8-9,11-12	N/A	2-1,5-4,8-7,11-10	
	<b>7403</b>	<b>U43</b>	ON	OFF	ON	2-3,5-6,8-9,11-12	OPEN	2-1,5-4,8-7,11-10	
	<b>7405</b>	<b>U45</b>	MOM.	OFF	MOM.				
	<b>7408</b>	<b>U48</b>	ON	NONE	MOM.	2-3,5-6,8-9,11-12	N/A	2-1,5-4,8-7,11-10	
	<b>7411*</b>	<b>U411*</b>	ON	ON	ON	2-3,5-6,8-9,11-12	2-3,5-4,8-9,11-10	2-1,5-4,8-7,11-10	
	<b>7413*</b>	<b>U413*</b>	ON	ON	MOM.				
	<b>7415*</b>	<b>U415*</b>	MOM.	ON	MOM.				

### 4PDT

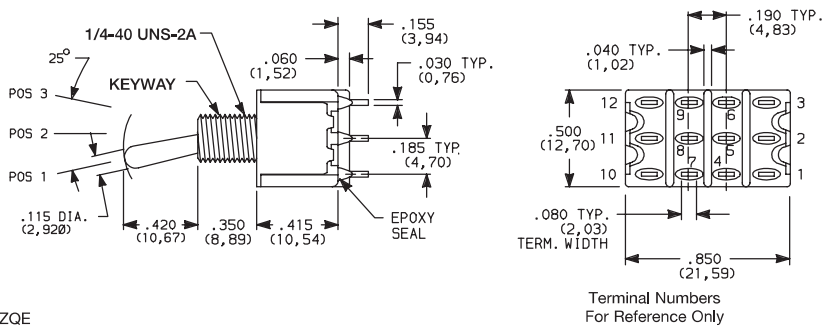

Part number shown: 7401SYZQE

Terminal Numbers  
For Reference Only

AOM. = Momentary

\*\* [Wiring for 3-way switch](#)

\*\* U11-U415 model nos. with all options when ordered with G, Q, R or S contact material.



Dimensions are shown: Inches (mm)  
Specifications and dimensions subject to change



F

Toggle

# KSD-7000 Series Miniature Toggle Switches



## ACTUATOR ACTUATOR FINISH

**S** .4206" HIGH <sup>1</sup>

**SP** ANTIROTATION, .4206" HIGH <sup>2,3</sup>

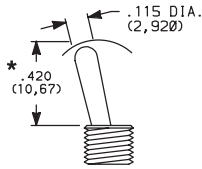

S actuator standard when ordered with C, W-W5, Z & Z3 terminations. Caps are available separately, see page F-16.

**M** .2006" HIGH <sup>1</sup>

**MP** ANTIROTATION, .2006" HIGH <sup>2,3</sup>

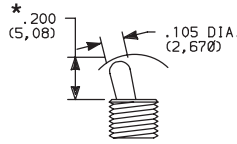

M actuator standard when ordered with all terminations except C, W-W5, Z & Z3. Caps are available separately, see page F-16.

**L, L1, L2** .8406", .6406", .5506" HIGH <sup>1</sup>

**L1P, L2P** ANTIROTATION, .8406", .6406", .5506" HIGH <sup>2,3</sup>

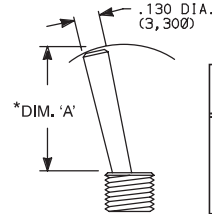

OPTION CODE	DIM 'A'
L	.840 (21,34)
L1, L1P	.640 (16,26)
L2, L2P	.550 (13,97)

Caps are available separately, see page F-16.

**\*P1** FLATTED WITH ANTIROTATION, .8406" HIGH <sup>2,3</sup>

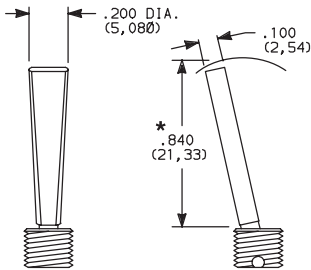

**\*P3** FLATTED WITH ANTIROTATION, .4506" HIGH <sup>2,3</sup>

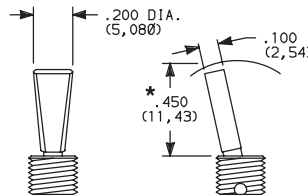

**\*P4** FLATTED WITH ANTIROTATION, .2506" HIGH <sup>2,3</sup>

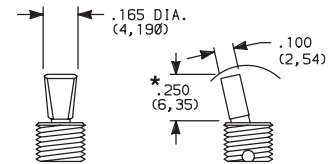

\*Dress nut part number 709901201 supplied standard with threaded bushing. (Part number 709903201 with metric threaded bushings.)

**T** .687 (17,45) HIGH <sup>1,2</sup>

**TP** ANTIROTATION, .687 (17,45) HIGH, 15/32 BUSHING <sup>1,2,3</sup>

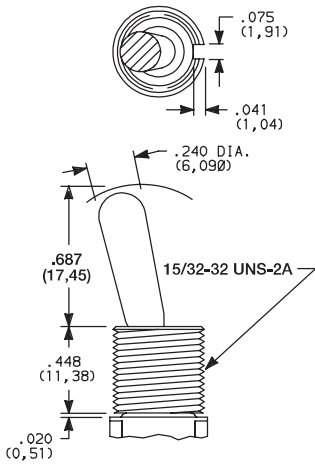

Bushing option code not required unless CW splashproof bushing ordered. TP & T1P actuators not available with CW splashproof bushing. All TXX actuators not available on single pole models with A-A4, AW1-AW4 terminations.

**T1** .487 (12,37) HIGH <sup>1,2</sup>

**T1P** ANTIROTATION, .487 (12,37) HIGH, 15/32 BUSHING <sup>1,2,3</sup>

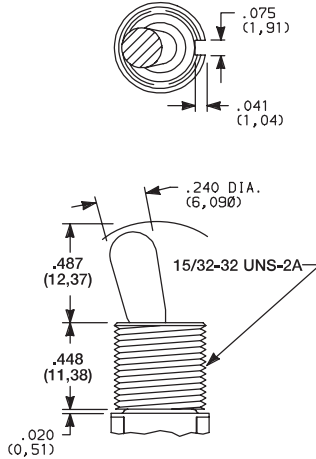

**T2P** FLATTED, ANTIROTATION, .6106" HIGH, 15/32 BUSHING <sup>1,2,3</sup>

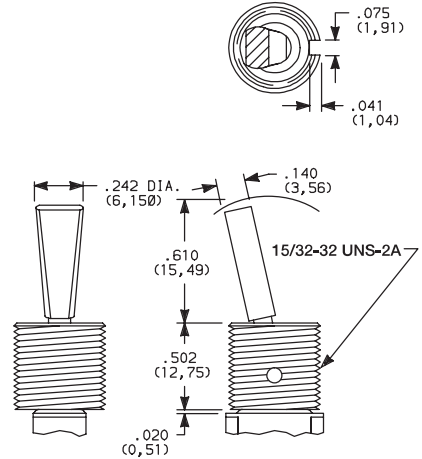

Bushing option code not required. T2P actuator not available with CW splashproof bushing or single pole models with A-A4, AW1-AW4 terminations.



**F**  
Toggle

- <sup>1</sup> L, L1, L2, M, S & TXX actuators not available with Y1 bushing.
- <sup>2</sup> L1P, L2P, MP, P1, P3, P4, SP & TXX actuators not available with D8 & H4 bushing.
- <sup>3</sup> Antirotation: Provides anti-'push-in' feature on actuator.
- \* Add .070 (1,78) for D, D8 & D9 bushings, subtract .020 (0,51) for H3 bushing.

OPTION CODE	ACTUATOR FINISH
<b>NONE</b>	BRIGHT CHROME-With Nickel Plated Bushing
<b>2</b>	BLACK
<b>S</b>	SATIN CHROME

**NOTE:** Black hardware is supplied when either black actuators or bushings are specified. For additional hardware, see Technical Data.

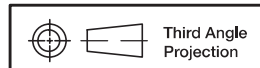

Dimensions are shown: Inches (mm)  
Specifications and dimensions subject to change

## ACTUATOR

ACTUATOR FINISH/COLOR



**K2** LOCKING LEVER, .704" HIGH (threaded)

**K9** LOCKING LEVER, .704" HIGH (unthreaded)

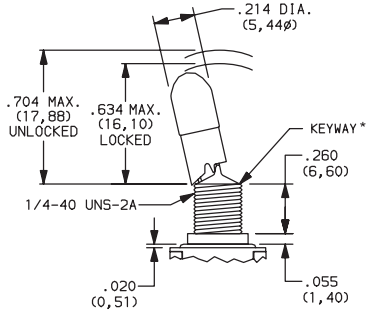

Replaces K, K8



**K12** LOCKING LEVER, .732" HIGH (threaded)

**K19** LOCKING LEVER, .732" HIGH (unthreaded)

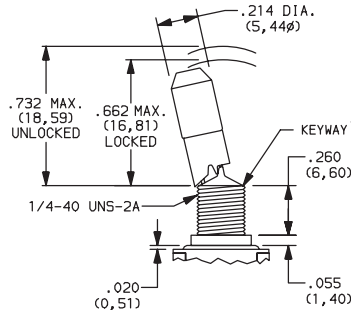

Replaces K1, K18



OPTION CODE	ACTUATOR CAP FINISH
NONE	NATURAL ALUMINUM-With Nickel Plated Bushing
2	BLACK ANODIZED ALUMINUM
3	RED ANODIZED ALUMINUM
7	BLUE ANODIZED ALUMINUM
G	GRIP TIP ALUMINUM

\* All KXX models including KXXCW have a keyway

### Locking Positions



-01 Models  
2 Position lock

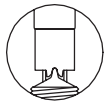

-03 & -11 Models  
3 Position lock



-05, -09 & -15 Models  
1 Position lock



-07 & -13 Models  
2 Position lock

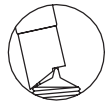

-08 Models  
1 Position lock

**NOTE:** To prevent accidental actuation, toggle must be lifted before being actuated. When released, toggle will lock in place. Overtightening mounting nut may cause actuator to bind.

Locking levers supplied with bushing shown.

Bushing option code not required unless CW splashproof bushing ordered.

**L40** LEVER HANDLE WITHOUT CAP

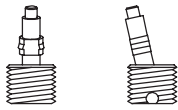

No color choice required

**L41** PLASTIC LEVER HANDLE WITH ANTIROTATION AND CAP, P/N 4810

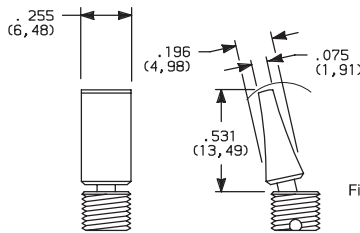

Finish: Matte (L41 & L42).

**L42** PLASTIC LEVER HANDLE WITH ANTIROTATION AND CAP, P/N 4811

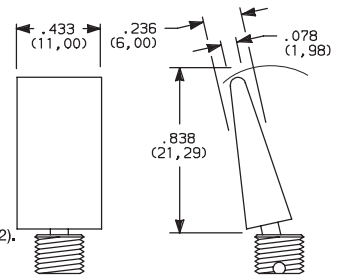

**L3** PLASTIC .940" HIGH

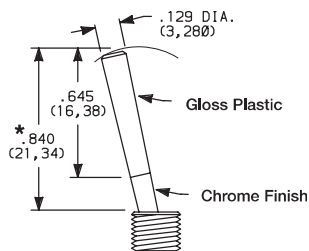

OPTION CODE	PLASTIC ACTUATOR COLORS
NONE	No Actuator Color (L40 option)
2	BLACK
3	RED

**NOTE:** Lever handle for L41 & L42 actuators supplied, but not installed. For interchangeability, order L40 actuator option and lever handles separately, see page F-16. L4X actuators not available with H4, Y1, Y4 bushings. Antirotation: Provides anti-'push-in' feature on actuator.

\* Add .070 (1,78) for D, D8 & D9 bushings, subtract .020 (0,51) for H3 bushing.



Dimensions are shown: Inches (mm)  
Specifications and dimensions subject to change



F

Toggle

# KSD-7000 Series Miniature Toggle Switches



## BUSHING

**Y** .350" HIGH, THREADED, KEYWAY

**Y9** .350" HIGH, UNTHREADED, KEYWAY

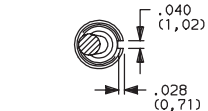

**NONE** NO BUSHING

No bushing choice required with KXX, TXX actuators, (exception: Specify CW if splashproof bushing desired).

**D** .280" HIGH, THREADED, KEYWAY

**D8** .280" HIGH, UNTHREADED, FLAT<sup>3</sup>

**D9** .280" HIGH, UNTHREADED, KEYWAY

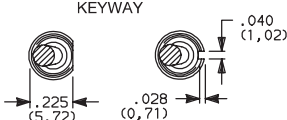

**H** .296" HIGH, FLAT THREADED, HIGH TORQUE 1,2

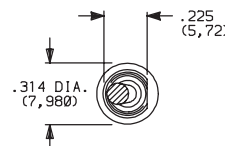

**H3** .315" HIGH, KEYWAY THREADED, HIGH TORQUE 1,2

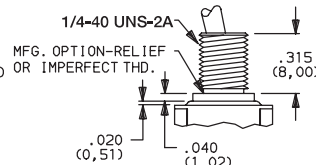
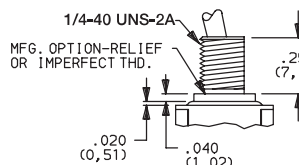
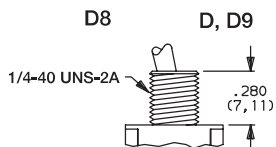
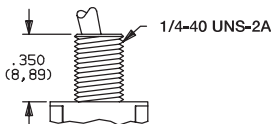
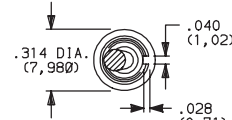

Y bushing standard with C, W-W5, Z or Z3 terminations.

D9 bushing standard with all terminations except C, W-W5, Z or Z3. Add .070 (1,78) to all actuators lengths with D, D8 & D9 bushings.

Subtract .020 (0,51) from all actuator lengths for H3 bushing.

**H4** 8mm HIGH, KEYWAY, THREADED, METRIC HIGH TORQUE 1,2,3

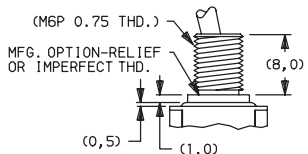
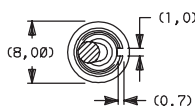

**Y1** .378" HIGH, KEYWAY, THREADED, HIGH TORQUE 1,2,4

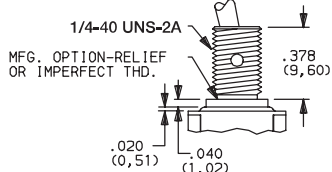
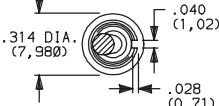

**Y3** 8,9mm HIGH, KEYWAY, THREADED, METRIC

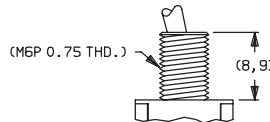
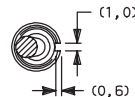

**Y4** .378" HIGH, FLAT, THREADED, HIGH TORQUE 1,2,5

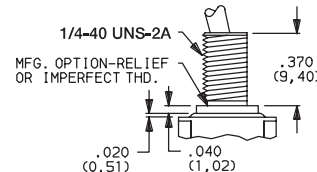
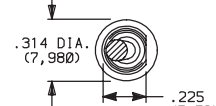

**CW** THREADED, SPLASHPROOF 1,2  
For T & T1 actuators.

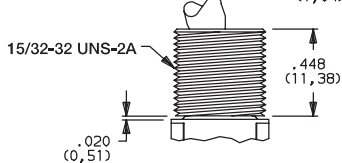
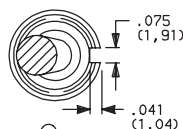

IP67 Degree of protection, totally protected against dust, full-scale voltage protection, temporary immersion. Internal actuator seal standard. External bushing seal available separately from APM Hexseal, part # MFS-60064.

For actuators other than T, T1 and KXX.

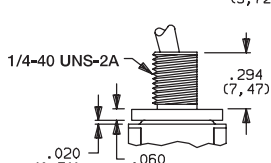
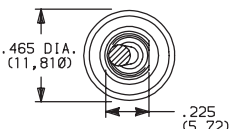

IP67 Degree of protection, totally protected against dust, full-scale voltage protection, temporary immersion. Internal actuator seal and external bushing seal washer standard. IP65 degree of protection for LXP, MP, PX or SP with CW option.

OPTION CODE	BUSHING FINISH
<b>NONE</b>	NICKEL on all bushings except 'D8' satin chrome.
<b>2</b>	BLACK

- 1 Will withstand 12 in.-lbs. of torque with no distortion.
- 2 CW, H, H3, H4, Y1 & Y4 bushings not available on single pole models with A4 terminations.
- 3 D8 & H4 bushings available only with L, L1, L2, M & S actuators.
- 4 Y1 bushing available only with LXP, MP, PX & SP actuators.
- 5 Y4 bushing not available with L4X actuators.

**NOTE:** Two mounting nuts, locking ring and lockwasher supplied standard with threaded bushings. Black hardware is supplied when either black bushings or actuators are specified. Optional mounting nut and locking ring styles and finishes available.

## PANEL MOUNTING

### 1/4 INCH BUSHING

### METRIC BUSHING

### 15/32 INCH BUSHING

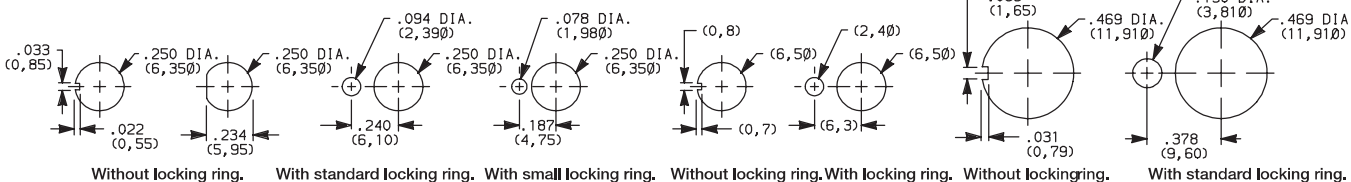

Dimensions are shown: mm  
Specifications and dimensions subject to change



## TERMINATIONS

### Z SOLDER LUG

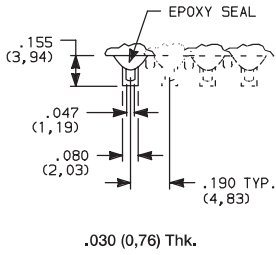

### C PC THRU-HOLE

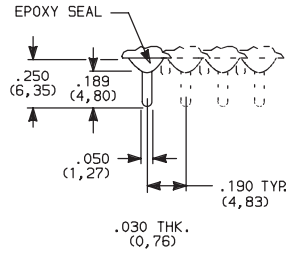

### PC MOUNTING

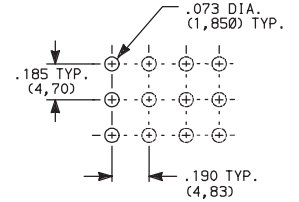

### SPDT thru 4PDT

Not available with P, R or S contact materials.

### SPDT thru 4PDT

### Z3 QUICK CONNECT

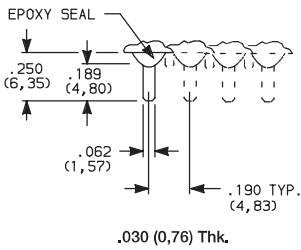

### W, W1, W3, W4, W5 WIRE WRAP

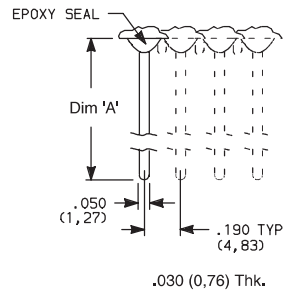

OPTION CODE	DIM 'A'
<b>W</b>	.750 (19,05)
<b>W1</b>	.964 (24,48)
<b>W3</b>	.425 (10,80)
<b>W4</b>	1.062 (26,97)
<b>W5</b>	1.305 (33,15)

### SPDT thru 4PDT

Not available with P, R or S contact materials. Mating quick connector available, order part number 530100000, page F-16.

### SPDT thru 4PDT

### A RIGHT ANGLE, PC THRU-HOLE

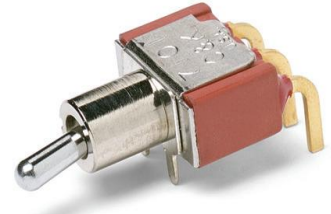
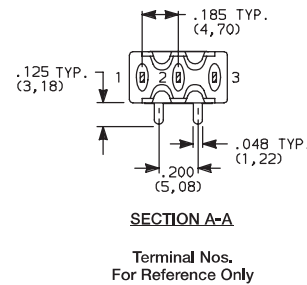
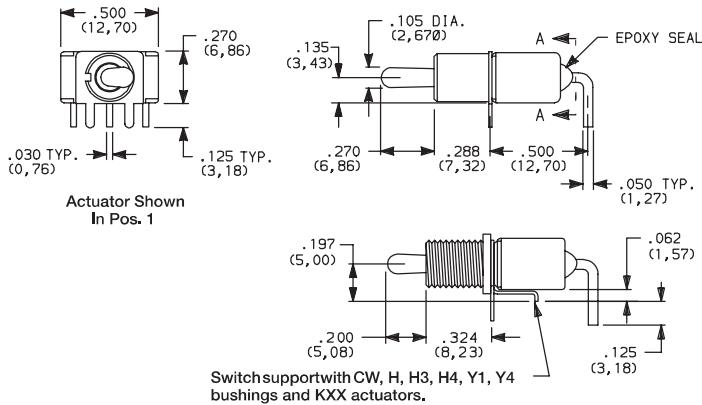

KSD-7101MD9ABE  
Horizontal Actuation  
SPDT

Part No. Shown: 7101MHABE

### A3 RIGHT ANGLE, SNAP-IN, PC THRU-HOLE

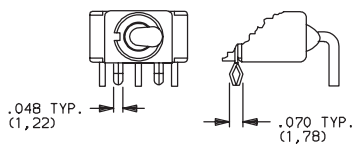

### AW1, AW4 RIGHT ANGLE, EXTENDED, PC THRU-HOLE

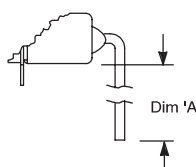

OPTION CODE	DIM 'A'
<b>AW1</b>	.72 (18,3)
<b>AW4</b>	.83 (21,1)

### PC MOUNTING

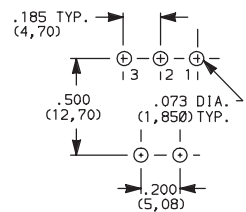

Not available with I seal option. Terminal bend radii and lead-in manufacturing option.



Dimensions are shown: Inches (mm)  
Specifications and dimensions subject to change



F

Toggle

# KSD-7000 Series Miniature Toggle Switches



## TERMINATIONS

**A** RIGHT ANGLE, PC THRU-HOLE

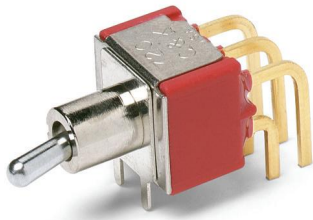

**KSD-7201MD9ABE**  
Horizontal Actuation  
**DPDT**

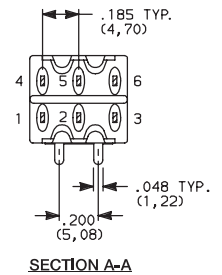
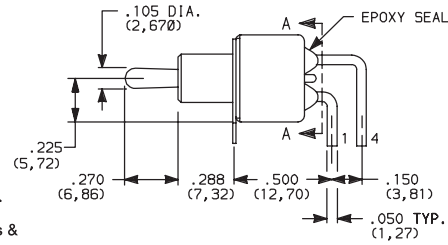
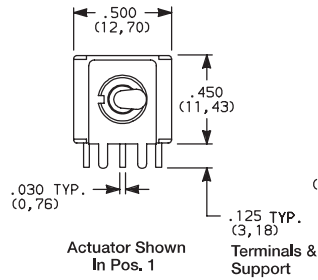

**A3** RIGHT ANGLE, SNAP-IN, PC THRU-HOLE

**AW1, AW4** RIGHT ANGLE, EXTENDED, PC THRU-HOLE

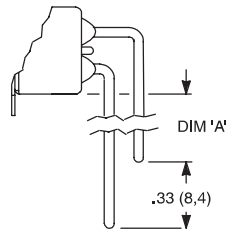
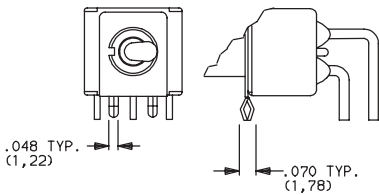

OPTION CODE	DIM 'A'
<b>AW1</b>	.40 (10,2)
<b>AW4</b>	.50 (12,7)

### PC MOUNTING

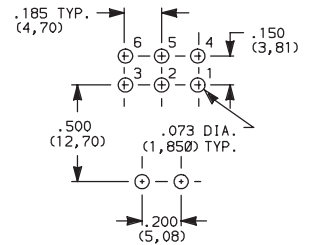

Not available with I seal option.  
Terminal bend radii and lead-in manufacturing option.

**A** RIGHT ANGLE, PC THRU-HOLE

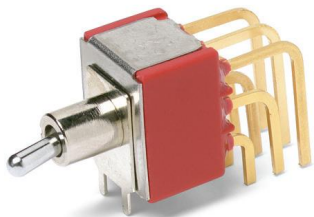

**KSD-7301MD9ABE**  
Horizontal Actuation  
**3PDT**

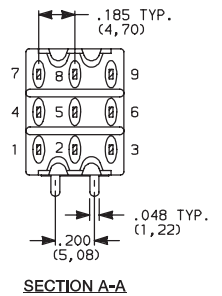
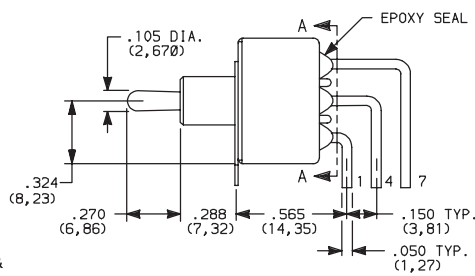
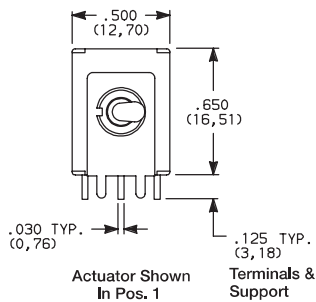

**AW4** RIGHT ANGLE, EXTENDED, PC THRU-HOLE

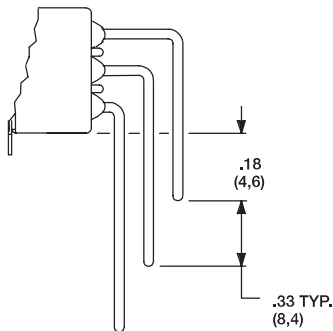

### PC MOUNTING

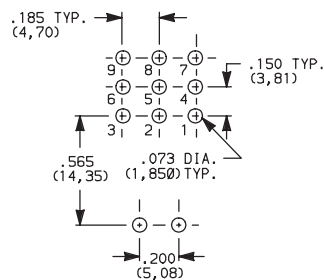

Not available with I seal option.  
Terminal bend radii and lead-in manufacturing option.

Dimensions are shown: mm  
Specifications and dimensions subject to change



**F**

**Toggle**

## TERMINATIONS

### A2 RIGHT ANGLE, PC THRU-HOLE, .156" PITCH

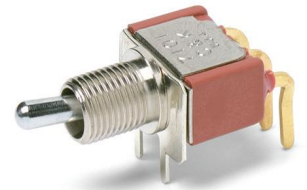
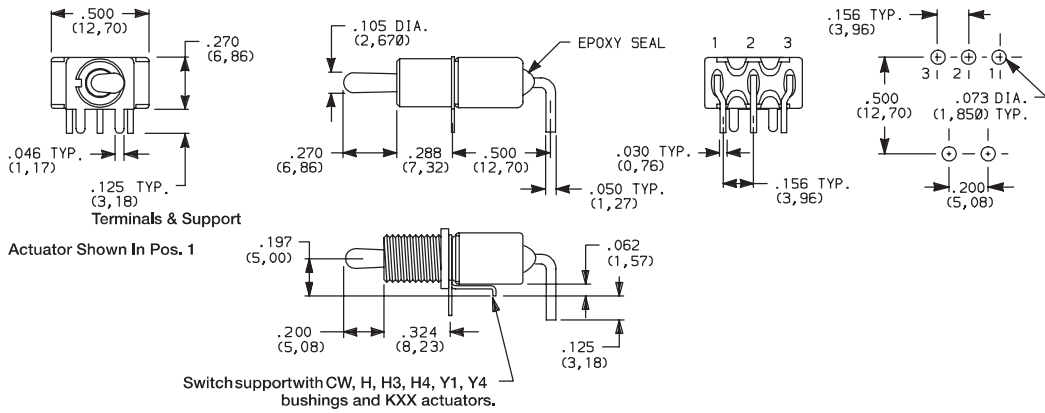

KSD-7101MHA2BE  
Horizontal Actuation  
**SPDT**

Not available with TXX actuators and I seal.  
Terminal bend radii and lead-in manufacturing option.

### A4 RIGHT ANGLE, PC THRU-HOLE, .156" PITCH

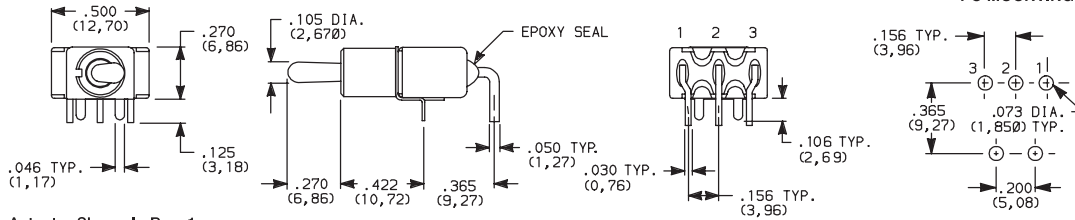

KSD-7101MD9A4BE  
Horizontal Actuation  
**SPDT**

Not available with KXX & TXX actuators, CW, H, H3, H4, Y1 & Y4 bushings, and I seal. Terminal bend radii and lead-in manufacturing option.

**NOTE:** The A4 option is available with any contact material and can be UL recognized and CSA certified. The PC pattern must clear switch support legs.

### AV2 VERTICAL RIGHT ANGLE, PC THRU-HOLE, .150" PITCH

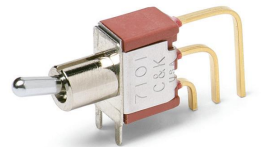
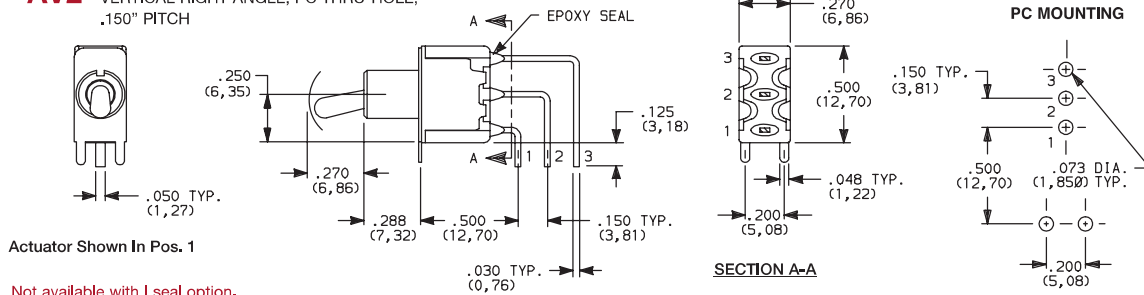

KSD-7101MD9AV2BE  
Horizontal Actuation  
**SPDT**

Not available with I seal option.  
Terminal bend radii and lead-in manufacturing option.

### AV2 VERTICAL RIGHT ANGLE, PC THRU-HOLE, .150" PITCH

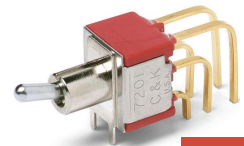
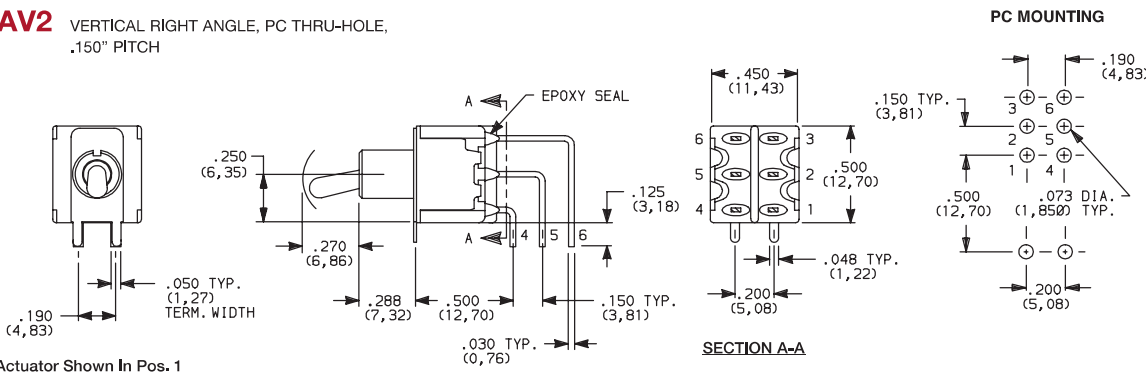

7201MD9AV2BE  
Vertical Actuation  
**DPDT**

Not available with I seal option.  
Terminal bend radii and lead-in manufacturing option.



Dimensions are shown: mm  
Specifications and dimensions subject to change

[www.bodongkaiguan.net](http://www.bodongkaiguan.net)



## TERMINATIONS

**V2, V6, V7, V8** VERTICAL MOUNT, V-BRACKET

**V21, V61, V71, V81** VERTICAL MOUNT, V-BRACKET, SNAP-IN

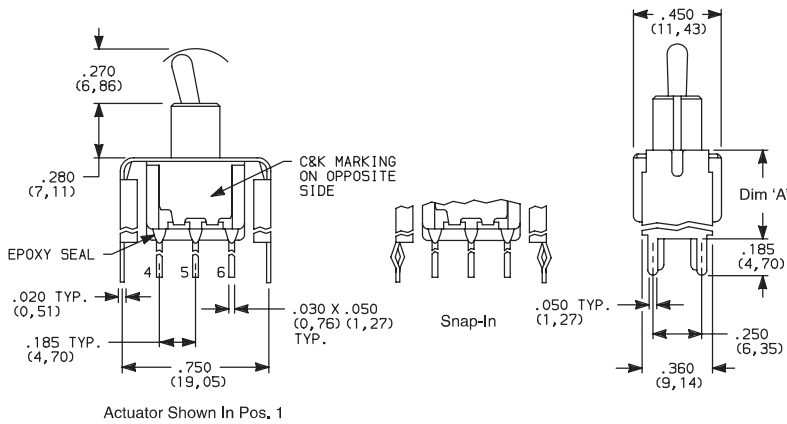

Not available with I seal option.

PC MOUNTING

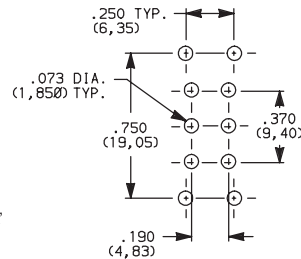

OPTION CODE	DIM 'A'
<b>V2, V21</b>	.555 (14,10)
<b>V6, V61</b>	.460 (11,68)
<b>V7, V71</b>	.630 (16,00)
<b>V8, V81</b>	.953 (24,21)

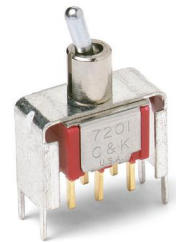

7201MD9\_BE  
DPDT

**V2, V7, V8** VERTICAL MOUNT, V-BRACKET

**V21, V71, V81** VERTICAL MOUNT, V-BRACKET, SNAP-IN

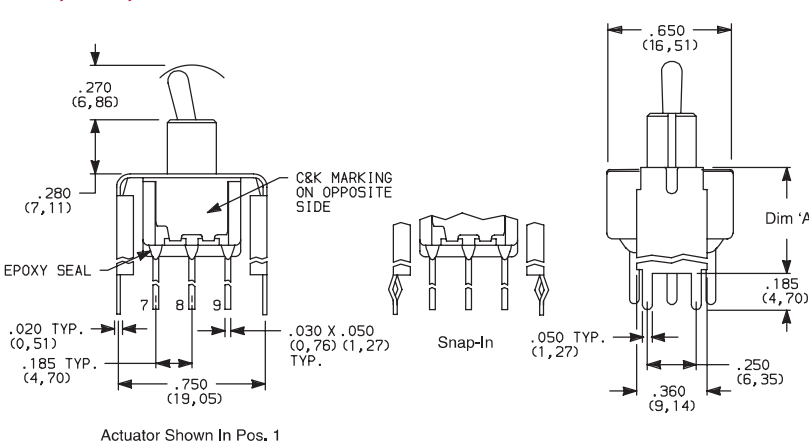

Not available with I seal option.

PC MOUNTING

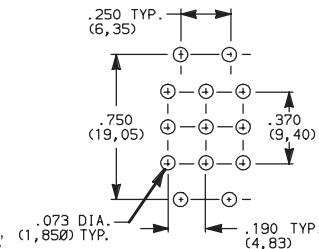

OPTION CODE	DIM 'A'
<b>V2, V21</b>	.555 (14,10)
<b>V7, V71</b>	.630 (16,00)
<b>V8, V81</b>	.953 (24,21)

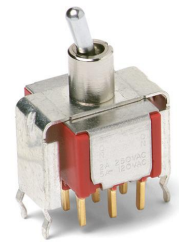

7301MD9\_BE  
3PDT

**V2, V7, V8** VERTICAL MOUNT, V-BRACKET

**V21, V71, V81** VERTICAL MOUNT, V-BRACKET, SNAP-IN

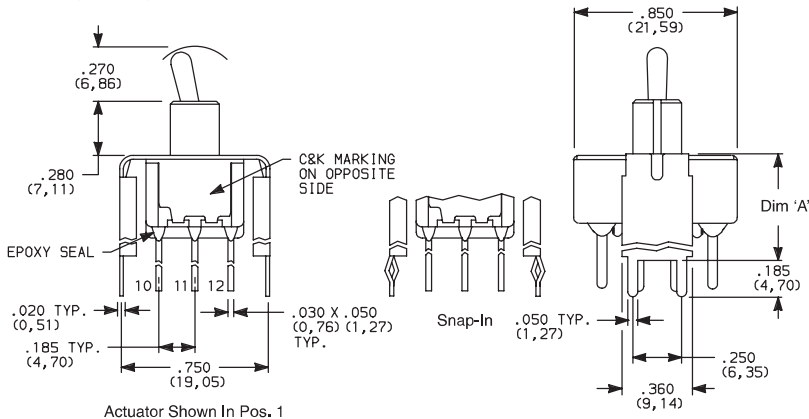

Not available with I seal option.

PC MOUNTING

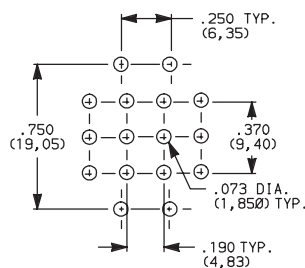

OPTION CODE	DIM 'A'
<b>V2, V21</b>	.555 (14,10)
<b>V7, V71</b>	.630 (16,00)
<b>V8, V81</b>	.953 (24,21)

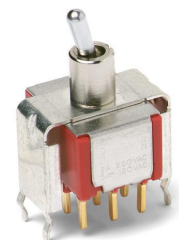

7401MD9\_BE  
4PDT



Dimensions are shown: mm  
Specifications and dimensions subject to change



F

Toggle

# KSD-7000 Series Miniature Toggle Switches



## TERMINATIONS

**V3, V4, V9** VERTICAL MOUNT, V-BRACKET

**V31, V41** VERTICAL MOUNT, V-BRACKET, SNAP-IN

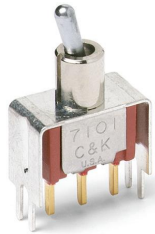

7101MD9\_BE  
SPDT

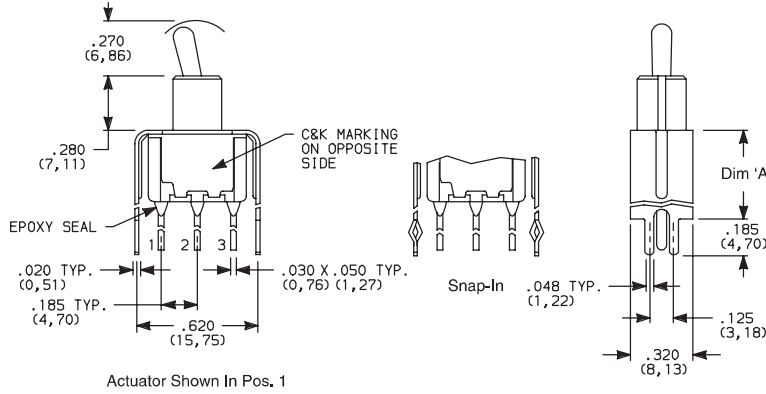

PC MOUNTING

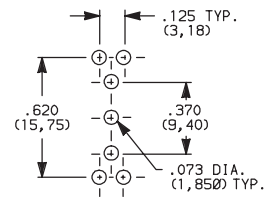

OPTION CODE	DIM 'A'
<b>V3, V31</b>	.460 (11,68)
<b>V4, V41</b>	.630 (16,00)
<b>V9</b>	1.150 (29,21)

Not available with I seal option.

**V3, V4, V9** VERTICAL MOUNT, V-BRACKET

**V31, V41** VERTICAL MOUNT, V-BRACKET, SNAP-IN

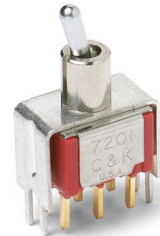

7201MD9\_BE  
DPDT

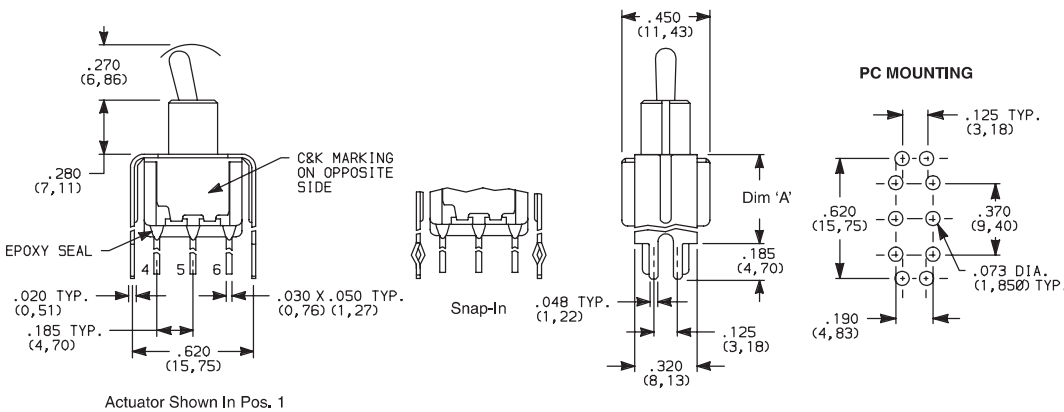

PC MOUNTING

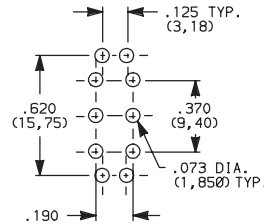

OPTION CODE	DIM 'A'
<b>V3, V31</b>	.460 (11,68)
<b>V4, V41</b>	.630 (16,00)
<b>V9</b>	1.150 (29,21)

Not available with I seal option.

**V4, V9** VERTICAL MOUNT, V-BRACKET

**V41** VERTICAL MOUNT, V-BRACKET, SNAP-IN



7301MD9\_BE  
3PDT

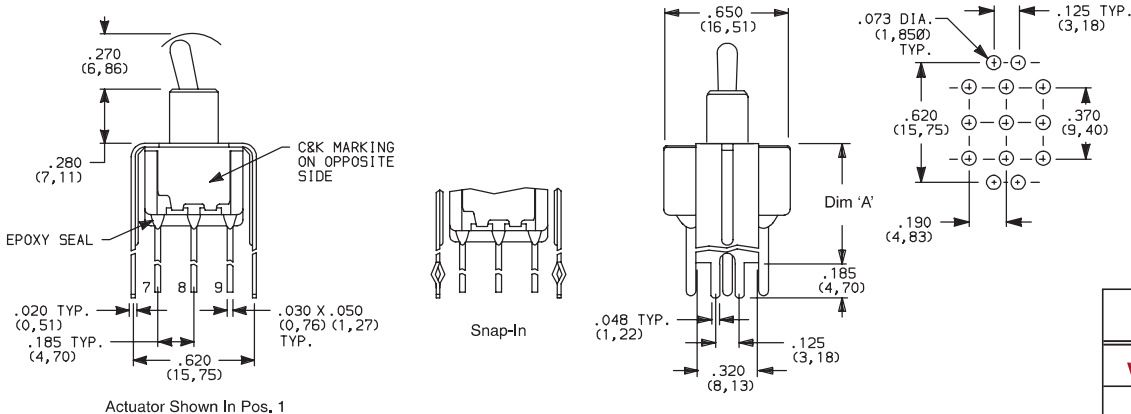

PC MOUNTING

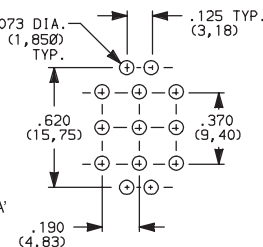

OPTION CODE	DIM 'A'
<b>V4, V41</b>	.630 (16,00)
<b>V9</b>	1.150 (29,21)

Not available with I seal option.

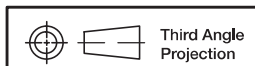

Dimensions are shown: mm  
Specifications and dimensions subject to change

www.bodongkaiguan.net

## TERMINATIONS

**V4, V9** VERTICAL MOUNT, V-BRACKET

**V41** VERTICAL MOUNT, V-BRACKET, SNAP-IN

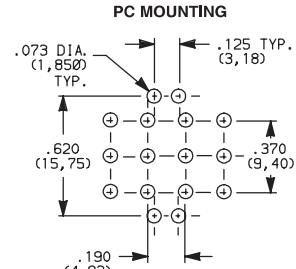
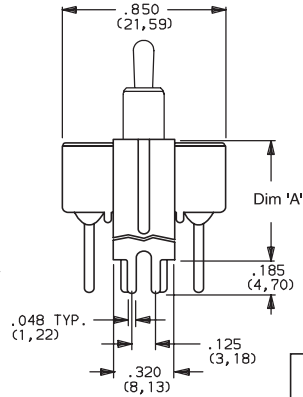
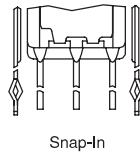
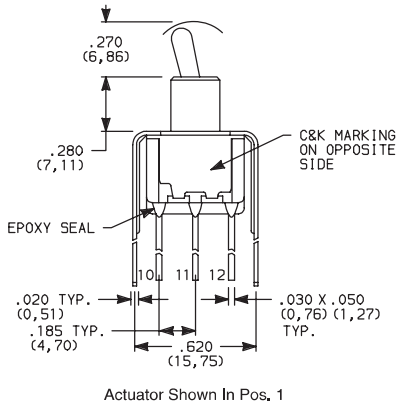

7401MD9\_BE  
4PDT

OPTION CODE	DIM 'A'
<b>V4, V41</b>	.630 (16,00)
<b>V9</b>	1.150 (29,21)

Not available with I seal option.

## CONTACT MATERIAL

OPTION CODE	CONTACT MATERIAL	TERMINAL PLATING	RATINGS	
<b>B</b>	GOLD <sup>1</sup>	GOLD <sup>1</sup>	LOW LEVEL/ DRY CIRCUIT	0.4 VA MAX. @ 20 V AC OR DC MAX.
<b>P</b>		MATTE-TIN <sup>6</sup>		
<b>Q</b>	SILVER <sup>4,5</sup>	SILVER <sup>5</sup>	POWER	5 AMPS @ 120 V AC OR 28 V DC; 2 AMPS @ 250 V AC.
<b>S</b>		MATTE-TIN <sup>6</sup>		
<b>G</b>	GOLD OVER SILVER <sup>2,3</sup>	GOLD <sup>3</sup>	LOW LEVEL/DRY CIRCUIT OR POWER	0.4 VA MAX @ 20 V AC OR DC MAX. OR 5 AMPS @ 120 V AC OR 28 V DC; 2 AMPS @ 250 V AC.
<b>R</b>		MATTE-TIN <sup>6</sup>		

\* Note: See Technical Data section of this catalog for RoHS compliant and compatible definitions and specifications.

- <sup>1</sup> CONTACTS & TERMINALS: Copper alloy, with gold plate over nickel plate.
- <sup>2</sup> END CONTACTS: Coin silver, with gold plate over nickel plate.
- <sup>3</sup> CENTER CONTACTS & ALL TERMINALS: Copper alloy, with gold plate over nickel plate.
- <sup>4</sup> END CONTACTS: Coin silver, silver plated.
- <sup>5</sup> CENTER CONTACT & ALL TERMINALS: Copper alloy, silver plated.
- <sup>6</sup> TERMINALS: Copper alloy, with matte tin alloy nickel plate.

**NOTE:** Any models supplied with P, S, R, Q, B or G contact material are RoHS compliant.

U11-U415 model numbers  with all options when ordered with G, S, R, or Q contact material.

B contact material standard with all terminations except C, Z & Z3.

Q contact material standard with C, Z & Z3 terminations.

P, S & R contact materials not available with Z & Z3 terminations.



F

Toggle

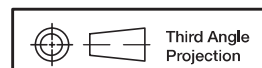

Dimensions are shown: Inches (mm)  
Specifications and dimensions subject to change

www.bodongkaiguan.net

# KSD-7000 Series Miniature Toggle Switches



## SEAL

**E** EPOXY SEAL



Compatible with "bottom-wash" PC board cleaning methods.

**I** EPOXY POTTED BASE

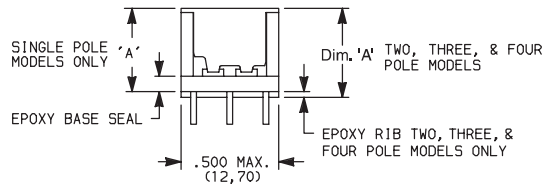

LENGTH IS SAME AS CASE LENGTH

NO. POLES	DIM 'A'
SP	.410 (10,41)
DP	.440 (11,18)
3P	.505 (12,83)
4P	.505 (12,83)

Available with C, W-W5, Z & Z3 terminations only.

## AVAILABLE HARDWARE

Cap

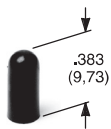

**PART NO.**

- 896801000** WHITE
- 896802000** BLACK
- 896803000** RED

Material: Polyethylene  
Finish: Matte

Cap

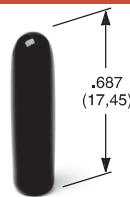

**PART NO.**

- 763701000** WHITE
- 763702000** BLACK
- 763703000** RED

Material: Vinyl  
Finish: Matte

Cap

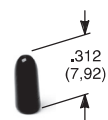

**PART NO.**

- 706201000** WHITE
- 706202000** BLACK
- 706203000** RED

Material: Vinyl  
Finish: Matte

L41 Lever handle

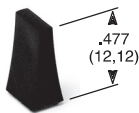

**PART NO.**

- 481001000** WHITE
- 481002263** BLACK
- 481003000** RED

Material: Nylon  
Finish: Matte

L42 Lever handle

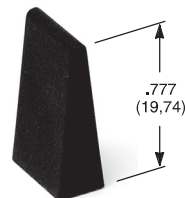

**PART NO.**

- 481101000** WHITE
- 481102263** BLACK
- 481103000** RED

Material: Nylon  
Finish: Matte

Fits Z3 Termination  
female connector



**PART NO.**

- 530100000**

Available in loose pieces.

**NOTE:** Additional nuts, locking rings and lockwashers available separately.

Other colors available, consult Customer Service Center.

759D02000 Sealing Boot

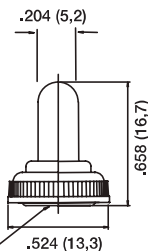

1/4-40 uns-2A nut

NOTE: For use with S actuator style when combined with D, H, H3, Y, and Y4 bushings

703D02000 Sealing Boot

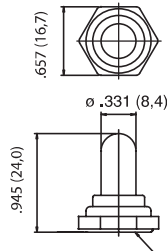

15/32-32 NS-2A

NOTE: For use with T and TP style actuators. **Cannot be used for Switch Functions: 7103, 7203, 7303, 7403, 7107, 7207, 7307, 7407.**

704D02000 Sealing Boot

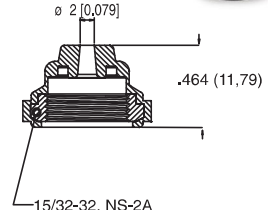

NOTE: For use with T, TP and T2P style actuators. **Cannot be used for Switch Functions: 7103, 7203, 7303, 7403, 7107, 7207, 7307, and 7407.**



Third Angle  
Projection

Dimensions are shown: mm  
Specifications and dimensions subject to change