

Features/Benefits

- Variety of actuators & terminations
- PC and panel mounting
- Shorting or non-shorting contacts
- RoHS compliant
- Halogen free material

Typical Applications

- Test & measurement equipment
- Computer peripherals & network products
- Consumer products

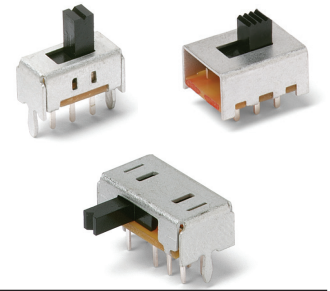

Specifications

CONTACT RATING: See individual parts.
 MECHANICAL & ELECTRICAL LIFE: 10,000 cycles.
 CONTACT RESISTANCE: 20 m Ω or less.
 INSULATION RESISTANCE: 100 M Ω min. at 500 VDC.
 DIELECTRIC STRENGTH: 500 VAC for 1 minute.
 OPERATING TEMPERATURE: -30°C to +70°C.
 PACKAGING: Bulk

* For RoHS compatible switches contact customer service.

Materials

BASE: Phenolic resin.
 ACTUATOR: Standard: POM, Black.
 High Temperature Option: PA46, Black.
 HOUSING: SPCC Sn plated.
 MOVABLE CONTACT: Copper alloy, silver plated.
 STATIONARY CONTACTS: Brass, silver plated.
 TERMINALS: Brass, silver plated.
 TERMINAL SEALED.

NOTE: Specifications and materials listed above are for switches with standard options. For information on specific and custom switches, consult Customer Service Center.

How To Order

Part number list is shown below. For individual part details, please refer to the following pages.

Part Number (Part Description)	Product Details
OS102011MS2QN1	SPDT, 2mm travel, Vertical, PC Thru-hole, Frame H=4.7mm, Tail L=2.8mm, Non shorting
OS102011MS2QN1C	SPDT, 2mm travel, Vertical, PC Thru-hole, Frame H=4.7mm, Tail L=2.8mm, Non shorting, High temperature resin
OS102011MS2QS1	SPDT, 2mm travel, Vertical, PC Thru-hole, Frame H=4.7mm, Tail L=2.8mm, Shorting
OS102011MS2QS1C	SPDT, 2mm travel, Vertical, PC Thru-hole, Frame H=4.7mm, Tail L=2.8mm, shorting, High temperature resin
OS103011MS8QP1	SP3T, 2mm travel, Vertical, PC Thru-hole, Frame H=4.7mm, Tail L=3.8mm, Not specified
OS103011MS8QP1C	SP3T, 2mm travel, Vertical, PC Thru-hole, Frame H=4.7mm, Tail L=3.8mm, Not specified, High temperature resin
OS202011MS2QS1	DPDT, 2mm travel, Vertical, PC Thru-hole, Frame H=4.7mm, Tail L=2.8mm, Shorting
OS202011MS2QN1	DPDT, 2mm travel, Vertical, PC Thru-hole, Frame H=4.7mm, Tail L=2.8mm, Non shorting
OS203011MS1QP1	DP3T, 2mm travel, Vertical, PC Thru-hole, Frame H=4.7mm, Tail L=3.6mm, Not specified
OS202013MT5QN1	DPDT, 3mm travel, Vertical, PC Thru-hole, Frame H=7.0mm, Tail L=2.8mm, Non shorting
OS203013MT7QN1	DP3T, 3mm travel, Vertical, PC Thru-hole, Frame H=7.5mm, Tail L=2.2mm, Non shorting
OS202013MT8QN1	DPDT, 3.2mm travel, Vertical, PC Thru-hole, Frame H=7.0mm, Tail L=2.5mm, Non shorting
OS203013MT8QN1	DP3T, 3.2mm travel, Vertical, PC Thru-hole, Frame H=7.0mm, Tail L=2.5mm, Non shorting
OS203013MT6QN1	DP3T, 3mm travel, Vertical, PC Thru-hole, Frame H=7.0mm, Tail L=2.9mm, Non shorting
OS103012MU1QP1	SP3T, 2.5mm travel, Vertical, PC Thru-hole, Frame H=5.2mm, Tail L=3.7mm, Not specified
OS103012MU2QP1	SP3T, 2.5mm travel, Vertical, PC Thru-hole, Frame H=5.2mm, Tail L=2.5mm, Not specified
OS203012MU5QP1	DP3T, 2.5mm travel, Vertical, PC Thru-hole, Frame H=5.2mm, Tail L=3.7mm, Not specified
OS202011MV4QN1	DPDT, 2mm travel, Vertical, PC Thru-hole, Frame H=8.5mm, Tail L=4.2mm, Non shorting



Dimensions are shown: Inches (mm)
 Specifications and dimensions subject to change



Slide

Part Number (Part Description)	Product Details
OS202011MV4QS1	DPDT, 2mm travel, Vertical, PC Thru-hole, Frame H=8.5mm, Tail L=4.2mm, shorting
OS203011MV9QS1	DP3T, 2mm travel, Vertical, PC Thru-hole, Frame H=8.5mm, Tail L=4.2mm, shorting
OS203011MV9QN1	DP3T, 2mm travel, Vertical, PC Thru-hole, Frame H=8.5mm, Tail L=4.2mm, Non shorting
OS102011MA1QN1	SPDT, 2mm travel, Right angle, PC Thru-hole, Frame H=4.7mm, Tail L=2.8mm, Non shorting
OS102011MA1QN1C	SPDT, 2mm travel, Right angle, PC Thru-hole, Frame H=4.7mm, Tail L=2.8mm, Non shorting, High temperature resin
OS102011MA1QS1	SPDT, 2mm travel, Right angle, PC Thru-hole, Frame H=4.7mm, Tail L=2.8mm, shorting
OS102011MA1QS1C	SPDT, 2mm travel, Right angle, PC Thru-hole, Frame H=4.7mm, Tail L=2.8mm, shorting, High temperature resin
OS103011MA7QP1	SP3T, 2mm travel, Right angle, PC Thru-hole, Frame H=4.7mm, Tail L=3.8mm, Not specified
OS103011MA7QP1C	SP3T, 2mm travel, Right angle, PC Thru-hole, Frame H=4.7mm, Tail L=3.8mm, Not specified, High temperature resin
OS203011MA2QP1	DP3T, 2mm travel, Right angle, PC Thru-hole, Frame H=4.7mm, Tail L=3.7mm, Not specified
OS202011MA0QN1	DPDT, 2mm travel, Right angle, PC Thru-hole, Frame H=4.7mm, Tail L=2.8mm, Non shorting
OS202011MA0QS1	DPDT, 2mm travel, Right angle, PC Thru-hole, Frame H=4.7mm, Tail L=2.8mm, shorting

PART NUMBER	RoHS Compliant	RoHS Compatible	SWITCH FUNCTION	
			POS.1	POS.2
OS102011MS2QN1 (non-shorting)	YES	NO		
OS102011MS2QN1C* (non-shorting)	YES	YES		
OS102011MS2QS1 (shorting)	YES	NO		
OS102011MS2QS1C* (shorting)	YES	YES		
CONN. TERMINALS			1-2	2-3
SCHEMATIC				

CONTACT RATING: 0.1A @ 12 VDC

* "C" option at the end of part number designates high temperature actuators

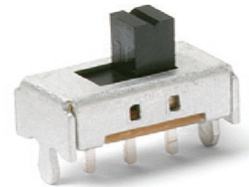
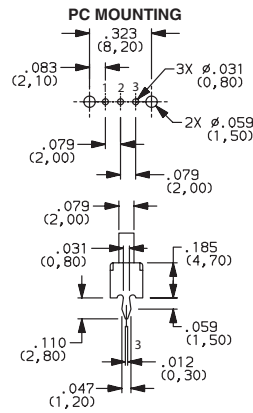
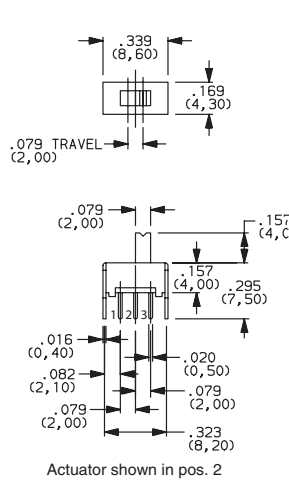

KSD-OS102011MS2QN1
SPDT

PART NUMBER	ROHS Compliant	ROHS Compatible	SWITCH FUNCTION		
			POS.1	POS.2	POS.3
OS103011MS8QP1 (Non-specified)	YES	NO			
OS103011MS8QP1C* (Non-specified)	YES	YES			
CONN. TERMINALS			1-2	2-3	2-4
SCHEMATIC					

CONTACT RATING: 0.1A @ 12 VDC

* "C" option at the end of part number designates high temperature actuators

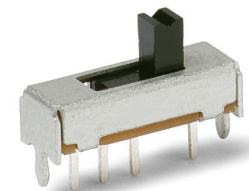
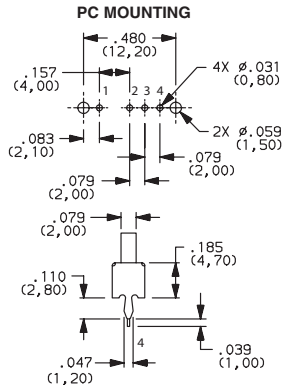
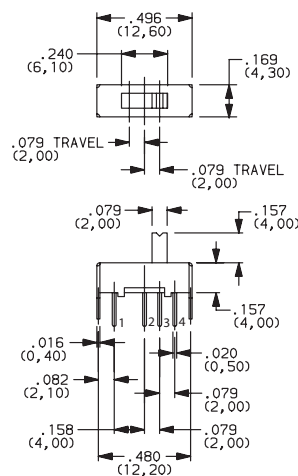

KSD-OS103011MS8QP1
SP3T

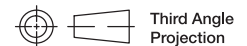

Dimensions are shown: Inches (mm)
Specifications and dimensions subject to change

KSD-OS Series Miniature Slide Switches

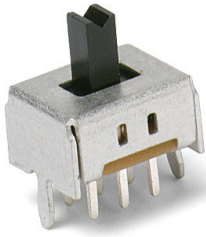

KSD-OS202011MS2QS1
DPDT

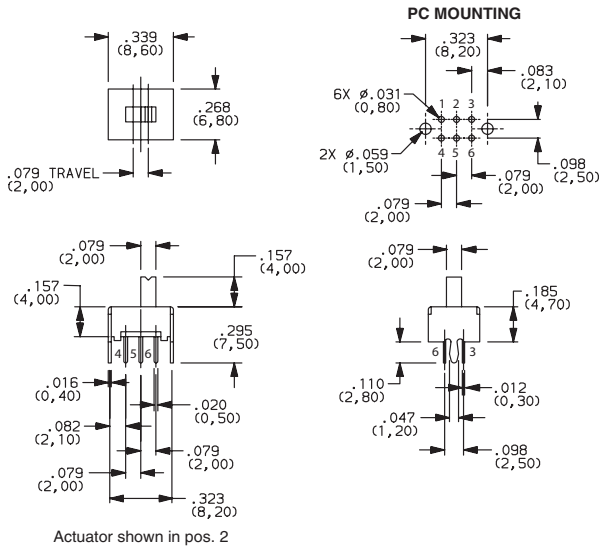

PART NUMBER	RoHS Compliant	RoHS Compatible	SWITCH FUNCTION	
			POS.1	POS.2
OS202011MS2QS1 (Shorting)	YES	NO	ON	ON
OS202011MS2QN1 (Non-shorting)	YES	NO	ON	ON
CONN. TERMINALS			1-2, 4-5	2-3, 5-6
SCHEMATIC				
DPDT				

CONTACT RATING: 0.1A @ 12 VDC

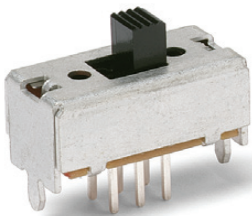

KSD-OS203011MS1QP1
DP3T

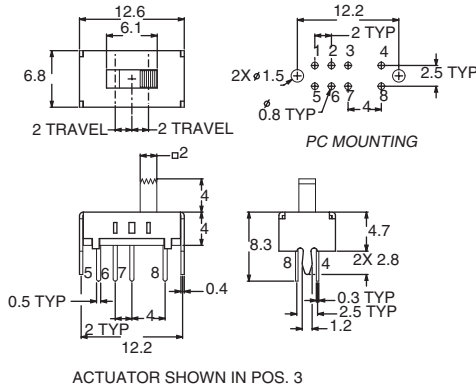

PART NUMBER	ROHS Compliant	ROHS Compatible	SWITCH FUNCTION		
			POS.1	POS.2	POS.3
OS203011MS1QP1 (Non-specified)	YES	NO	ON	ON	ON
CONN. TERMINALS			1-3, 5-7	2-3, 6-7	3-4, 7-8
SCHEMATIC					
DP3T					

CONTACT RATING: 0.3A @ 30 VDC

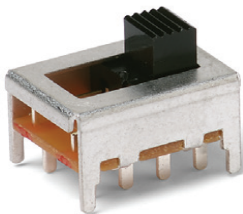

KSD-OS202013MT5QN1
DPDT

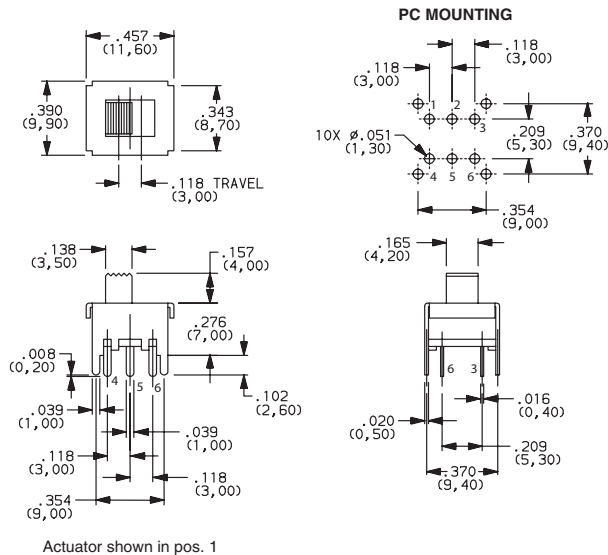

PART NUMBER	RoHS Compliant	RoHS Compatible	SWITCH FUNCTION	
			POS.1	POS.2
OS202013MT5QN1 (Non-shorting)	YES	NO	ON	ON
CONN. TERMINALS			1-2, 4-5	2-3, 5-6
SCHEMATIC				
DPDT				

CONTACT RATING: 0.3A @ 30 VDC

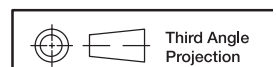

Dimensions are shown: Inch (mm)
Specifications and dimensions subject to change

PART NUMBER	ROHS Compliant	ROHS Compatible	SWITCH FUNCTION		
			POS.1	POS.2	POS.3
OS203013MT7QN1 (Non-shorting)	YES	NO	ON	OFF	ON
CONN. TERMINALS			1-2, 4-5		2-3, 5-6
SCHEMATIC					
DP3T					

CONTACT RATING: 0.3A @ 30 VDC

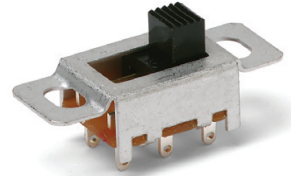
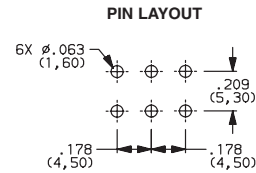
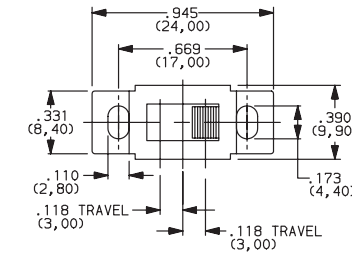

KSD-OS203013MT7QN1
DP3T



Slide

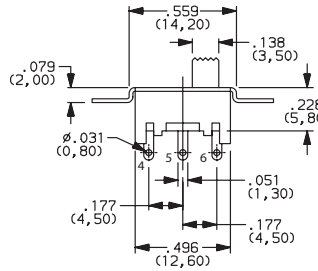

Actuator shown in pos. 3

PART NUMBER	RoHS Compliant	RoHS Compatible	SWITCH FUNCTION	
			POS.1	POS.2
OS202013MT8QN1 (Non-shorting)	YES	NO	ON	ON
CONN. TERMINALS			1-2, 4-5	2-3, 5-6
SCHEMATIC				
DPDT				

CONTACT RATING: 0.3A @ 30 VDC

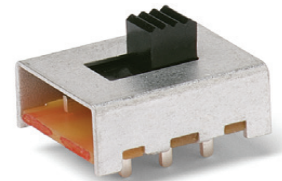
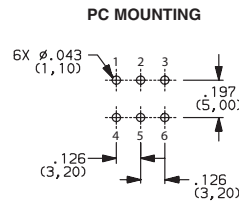
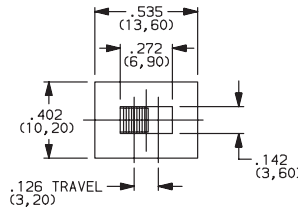

KSD-OS202013MT8QN1
DPDT

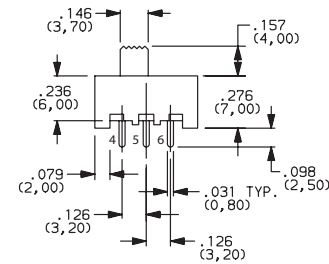

Actuator shown in pos. 1

PART NUMBER	ROHS Compliant	ROHS Compatible	SWITCH FUNCTION		
			POS.1	POS.2	POS.3
OS203013MT8QN1 (Non-shorting)	YES	NO	ON	ON	ON
CONN. TERMINALS			1-2, 5-6	2-3, 6-7	3-4, 7-8
SCHEMATIC					
DP3T					

CONTACT RATING: 0.3A @ 30 VDC

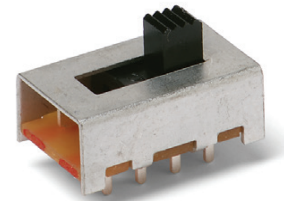
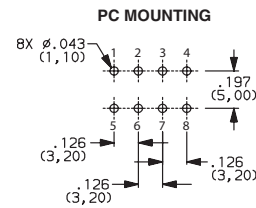
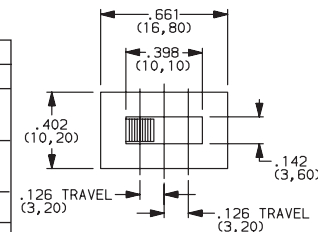

KSD-OS203013MT8QN1
DP3T

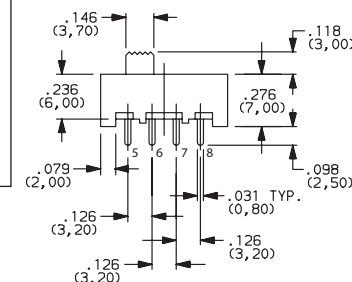

Actuator shown in pos. 1

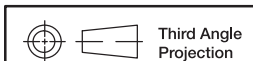

Dimensions are shown: Inches (mm)
Specifications and dimensions subject to change

KSD-OS Series Miniature Slide Switches

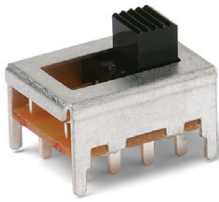

KSD-OS203013MT6QN1
DP3T

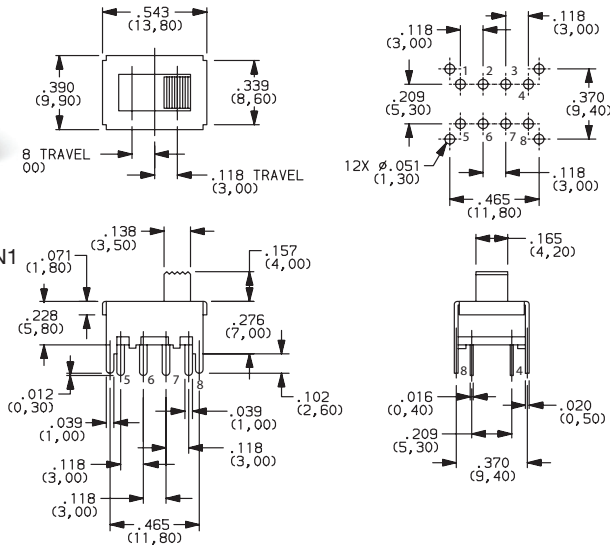

PART NUMBER	ROHS Compliant	ROHS Compatible	SWITCH FUNCTION		
			POS.1	POS.2	POS.3
OS203013MT6QN1 (Non-shorting)	YES	NO	ON	ON	ON
CONN. TERMINALS			1-2, 5-6	2-3, 6-7	3-4, 7-8
SCHEMATIC					
DP3T					

CONTACT RATING: 0.2A @ 30 VDC

Slide

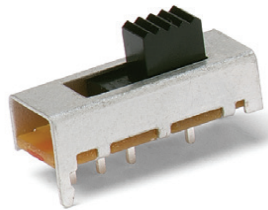

KSD-OS103012MU1QP1
SP3T

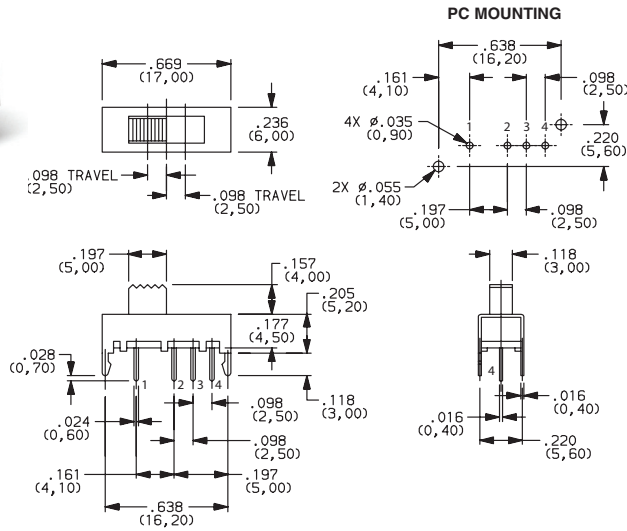

PART NUMBER	ROHS Compliant	ROHS Compatible	SWITCH FUNCTION		
			POS.1	POS.2	POS.3
OS103012MU1QP1 (Non-shorting)	YES	NO	ON	ON	ON
CONN. TERMINALS			1-2	2-3	2-4
SCHEMATIC					
SP3T					

CONTACT RATING: 0.2A @ 30 VDC

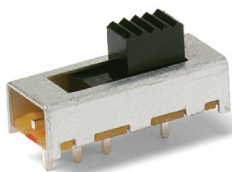

KSD-OS103012MU2QP1
SP3T

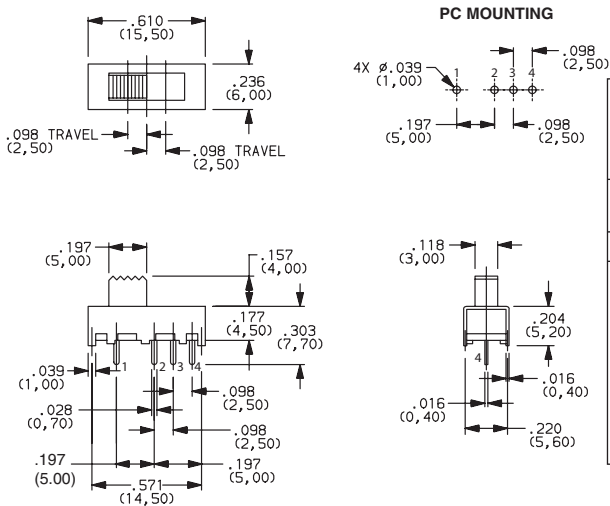

PART NUMBER	ROHS Compliant	ROHS Compatible	SWITCH FUNCTION		
			POS.1	POS.2	POS.3
OS103012MU2QP1 (Non-shorting)	YES	NO	ON	ON	ON
CONN. TERMINALS			1-2	2-3	2-4
SCHEMATIC					
SP3T					

CONTACT RATING: 0.2A @ 30 VDC



Dimensions are shown: Inch (mm)

Specifications and dimensions subject to change

www.bodongkalguan.net

PART NUMBER	ROHS		SWITCH FUNCTION		
	Compliant	Compatible	POS.1	POS.2	POS.3
OS203012MU5QP1 (Non-specified)	YES	NO	ON	ON	ON
CONN. TERMINALS			1-2, 5-6	2-3, 6-7	2-4, 6-8
SCHEMATIC					
DP3T					

CONTACT RATING: 0.1A @ 30 VDC

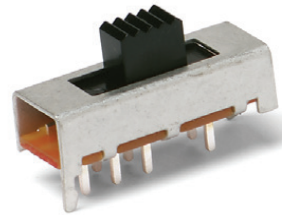
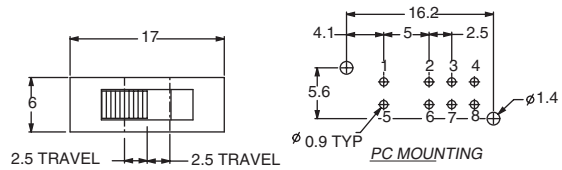

KSD-OS203012MU5QP1
DP3T

Slide

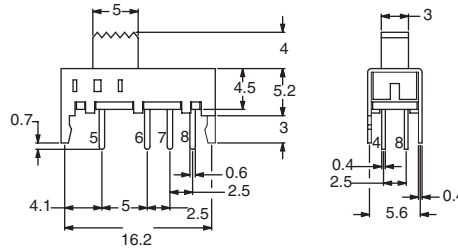

ACTUATOR SHOWN IN POS. 1

PART NUMBER	ROHS		SWITCH FUNCTION	
	Compliant	Compatible	POS.1	POS.2
OS202011MV4QN1 (Non-shorting)	YES	NO	ON	ON
OS202011MV4QS1 (Shorting)	YES	NO	ON	ON
CONN. TERMINALS			1-2, 4-5	2-3, 5-6
SCHEMATIC				
DPDT				

CONTACT RATING: 0.1A @ 30 VDC

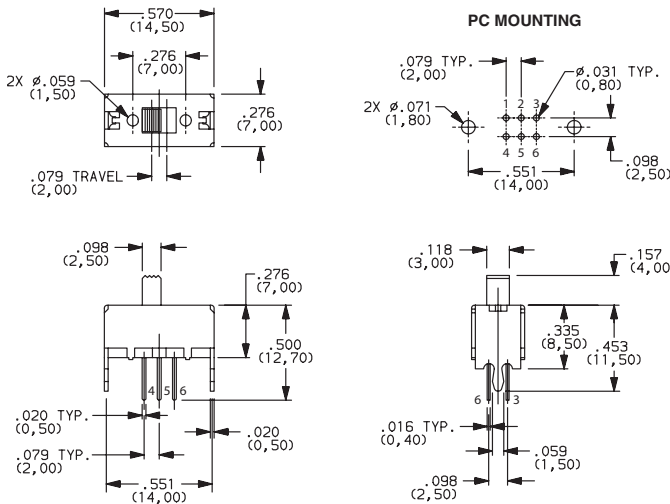

Actuator shown in pos. 1

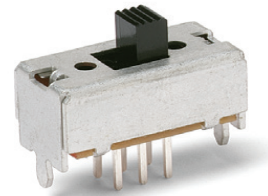

KSD-OS202011MV4QN1
DPDT

PART NUMBER	ROHS		SWITCH FUNCTION		
	Compliant	Compatible	POS.1	POS.2	POS.3
OS203011MV9QS1 (Shorting)	YES	NO	ON	ON	ON
OS203011MV9QN1 (Non-Shorting)	YES	NO	ON	ON	ON
CONN. TERMINALS			1-2-5 6-7-10	1-3-5 6-8-10	1-4-5 6-9-10
SCHEMATIC					
DP3T					

CONTACT RATING: 0.1A @ 30 VDC

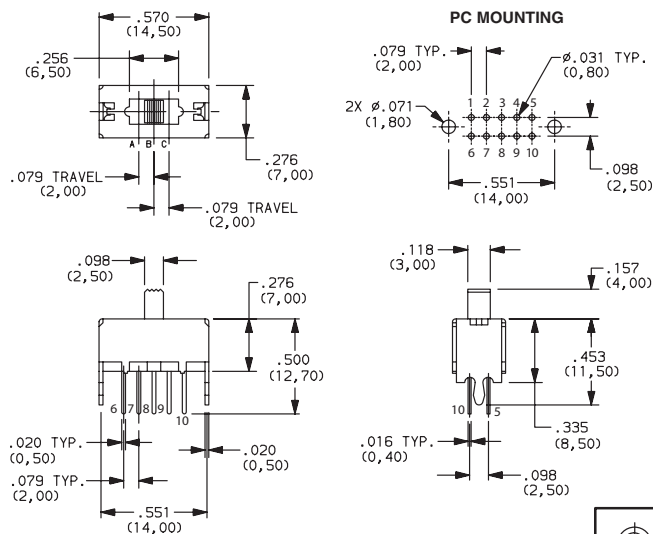

Actuator shown in pos. 2(A)

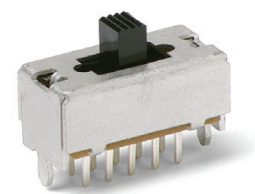

KSD-OS203011MV9QS1
DP3T



Third Angle
Projection

Dimensions are shown: Inches (mm)
Specifications and dimensions subject to change

KSD-OS Series Miniature Slide Switches

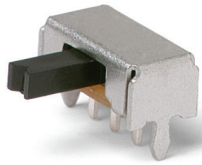

KSD-OS102011MA1QN1
SPDT

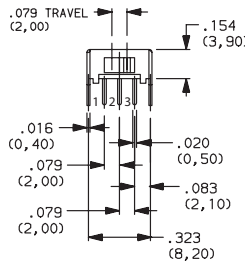
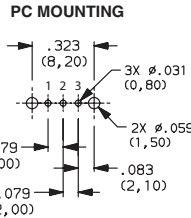
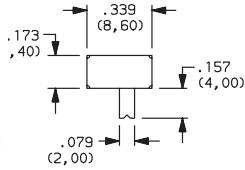

Actuator shown in pos. 2

PART NUMBER	RoHS Compliant	RoHS Compatible	SWITCH FUNCTION	
			POS.1	POS.2
OS102011MA1QN1 (Non-shorting)	YES	NO	ON	ON
OS102011MA1QN1C* (Non-shorting)	YES	YES	ON	ON
OS102011MA1QS1 (Shorting)	YES	NO	ON	ON
OS102011MA1QS1C* (Shorting)	YES	YES	ON	ON
CONN. TERMINALS			1-2	2-3
SCHEMATIC				
SPDT				

CONTACT RATING: 0.1A @ 12 VDC

* "C" option at the end of part number designates high temperature actuators

Slide

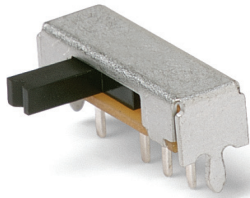

KSD-OS103011MA7QP1
SP3T

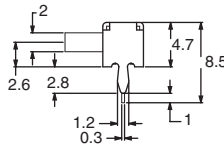
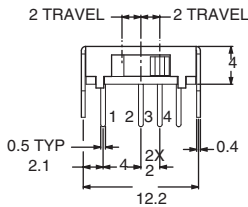
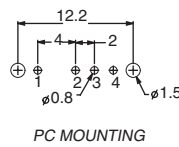
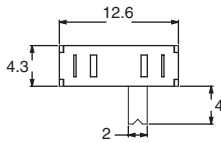

PART NUMBER	ROHS Compliant	ROHS Compatible	SWITCH FUNCTION		
			POS.1	POS.2	POS.3
OS103011MA7QP1 (Non-specified)	YES	NO	ON	ON	ON
OS103011MA7QP1C* (Non-specified)	YES	YES	ON	ON	ON
CONN. TERMINALS			1-2	2-3	2-4
SCHEMATIC					
SP3T					

CONTACT RATING: 0.1A @ 12 VDC

* "C" option at the end of part number designates high temperature actuators

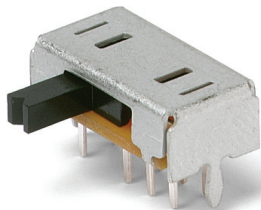

KSD-OS203011MA2QP1
DP3T

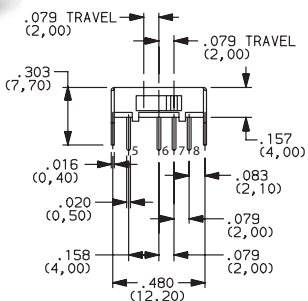
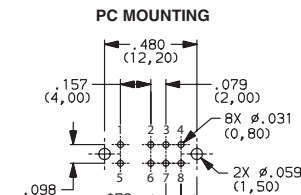
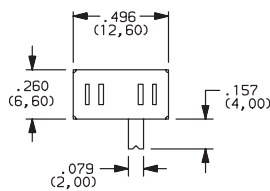

Actuator shown in pos. 3

PART NUMBER	RoHS Compliant	RoHS Compatible	SWITCH FUNCTION		
			POS.1	POS.2	POS.3
OS203011MA2QP1 (Non-specified)	YES	NO	ON	ON	ON
CONN. TERMINALS			1-2, 5-6	2-3, 6-7	2-4, 6-8
SCHEMATIC					
DP3T					

CONTACT RATING: 0.1A @ 12 VDC



Third Angle Projection

Dimensions are shown: Inch (mm)
Specifications and dimensions subject to change

www.bodongkaiquan.net

PART NUMBER	RoHS Compliant	RoHS Compatible	SWITCH FUNCTION	
			POS.1	POS.2
OS202011MA0QN1 (Non-shorting)	YES	NO	ON	ON
OS202011MA0QS1 (Shorting)	YES	NO	ON	ON
CONN. TERMINALS			1-2, 4-5	2-3, 5-6
SCHEMATIC				
DPDT				

CONTACT RATING: 0.1A @ 12 VDC

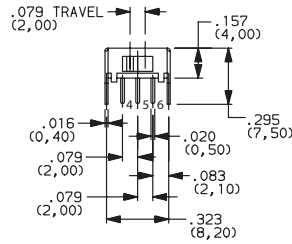
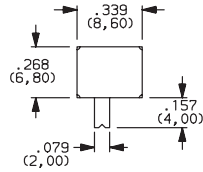

Actuator shown in pos. 1

PC MOUNTING

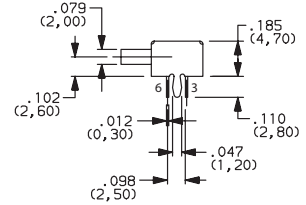
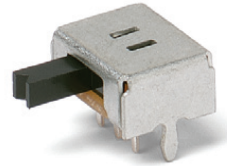
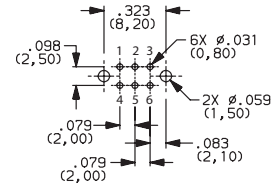

KSD-OS202011MA0QN
DPDT



Slide



Dimensions are shown: Inches (mm)
Specifications and dimensions subject to change