

Features/Benefits

- **Process sealed – withstands soldering and cleaning**
- **Thru-hole and surface mount models**
- **Crisp, positive detent ensures actuation**
- **Computer and peripherals**
- **RoHS compliant**
- **IP65**

Typical Applications

- **Address switching applications**
- **Data storage devices**
- **Computer and peripherals**
- **Instrumentation**

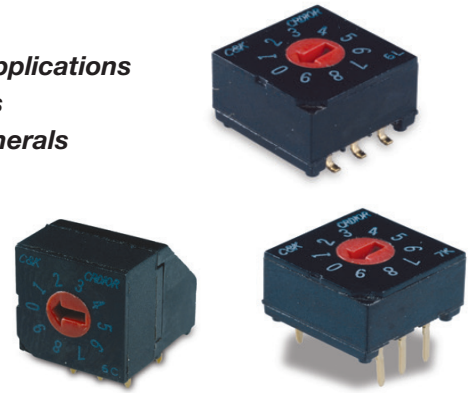

Specifications

CONTACT RATING: 0.4 V AC, DC 20 V max.
 ELECTRICAL LIFE: 20,000 steps min. @ 5 V DC 10 mA.
 MECHANICAL LIFE: 30,000 steps min.
 CONTACT RESISTANCE: 100 milliohms max. initial @ 2 V DC 10 mA.
 INSULATION RESISTANCE: 1000 megohms min. @ 100 V DC
 DIELECTRIC STRENGTH: 300 V AC for 1 minute.
 OPERATING TEMPERATURE: -20°C to 85°C.
 STORAGE TEMPERATURE: -40°C to 85°C.
 OPERATING FORCE: 1000 grams max.
 PACKAGING: Switches supplied in anti-static tubes in full quantities only. This may affect order quantity. Surface mount models with MO actuators available in tape and reel, 500 pieces per reel.

Materials

COVER: PPS (black)
 HOUSING: PPS (black)
 ACTUATOR: PA 6T M0 actuator option; PBT L1 and W1 actuator option.
 CONTACTS: Beryllium Copper with Gold over Nickel plate
 TERMINALS: Brass with Gold Nickel plate.

Note: Specifications and materials listed above are for switches with standard options. For information on specific and custom switches, consult Customer Service Center.

How To Order

The Build-A Switch concept allows you to mix and match options to create the switch you need. Below is a complete listing of options shown in catalog. To order, simply select desired option from each category and place in the appropriate box.

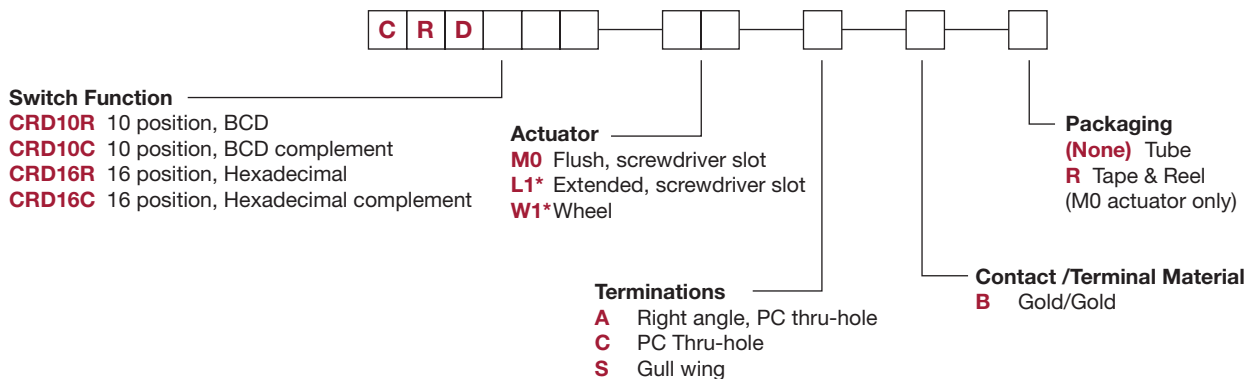

* Note - L1 and W1 actuators are not available in termination "S"



Dimensions are shown: Inch (mm)
 Specifications and dimensions subject to change

KSD-CRD Series 10mm DIP Coded Rotary Switches



SWITCHES WITH STANDARD OPTIONS

PC Mount

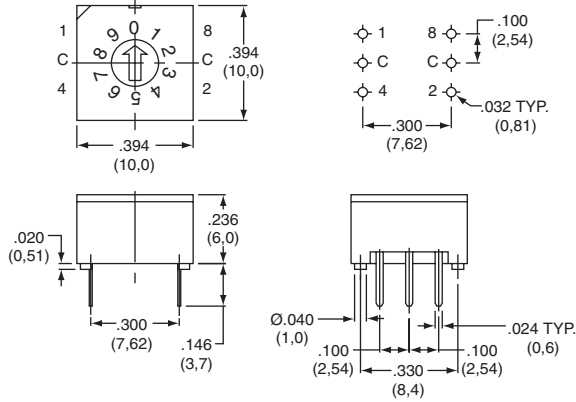
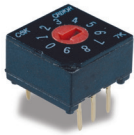

PART NUMBER	NO. POS.	QUANTITY PER TUBE
CRD10RM0CB	10	45
CRD16RM0CB	16	45

Right Angle Mount

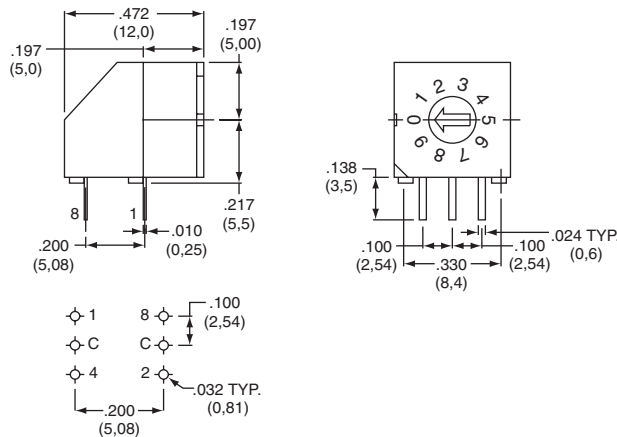

PART NUMBER	NO. POS.	QUANTITY PER TUBE
CRD10RM0AB	10	45
CRD16RM0AB	16	45

Surface Mount

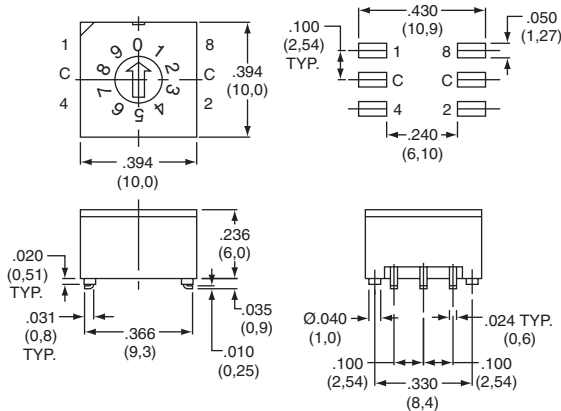

PART NUMBER	NO. POS.	QUANTITY PER TUBE
CRD10RM0SB	10	45
CRD16RM0SB	16	45

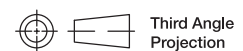

Third Angle Projection

Dimensions are shown: Inch (mm)
Specifications and dimensions subject to change

SWITCH FUNCTION



DIP

DIP

CRD10R

10 POSITION, BCD
ACTUATOR COLOR: RED

POS.	0	1	2	3	4	5	6	7	8	9
C	●	●	●	●	●	●	●	●	●	●
1		●		●		●		●		●
2			●		●		●		●	
4				●	●	●	●			
8								●	●	

Switches ship and to be solder processed in position "0"

CRD10C

10 POSITION, BCD COMPLEMENT
ACTUATOR COLOR: ORANGE

POS.	0	1	2	3	4	5	6	7	8	9
C	●	●	●	●	●	●	●	●	●	●
1	●		●		●		●		●	
2	●			●			●			●
4	●	●	●	●					●	●
8	●	●	●	●	●	●	●	●		

Switches ship and to be solder processed in position "7"

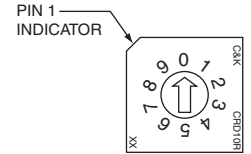

CRD16R

16 POSITION, HEXADECIMAL
ACTUATOR COLOR: BLACK

POS.	0	1	2	3	4	5	6	7	8	9	A	B	C	D	E	F
C	●	●	●	●	●	●	●	●	●	●	●	●	●	●	●	●
1		●		●		●		●		●		●		●		●
2			●		●		●		●		●		●		●	
4				●	●	●					●	●	●			
8							●	●	●	●	●	●	●	●	●	●

Switches ship and to be solder processed in position "0"

CRD16C

16 POSITION, HEXADECIMAL COMPLEMENT
ACTUATOR COLOR: WHITE

POS.	0	1	2	3	4	5	6	7	8	9	A	B	C	D	E	F
C	●	●	●	●	●	●	●	●	●	●	●	●	●	●	●	●
1	●		●		●		●		●		●		●		●	
2	●			●			●			●		●			●	
4	●	●	●	●					●	●	●	●				
8	●	●	●	●	●	●	●	●	●	●	●	●	●	●	●	●

Switches ship and to be solder processed in position "F"

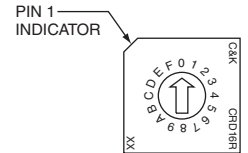

ACTUATOR



(STD.) FLUSH WITH SCREWDRIVER SLOT

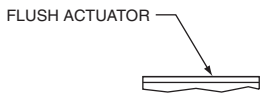
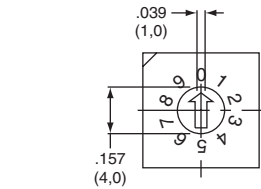

L1*

EXTENDED WITH SCREWDRIVER SLOT

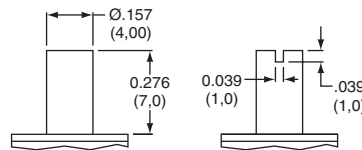
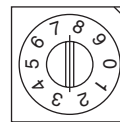

W1*

WHEEL

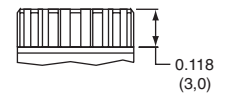

NOTE: Designed for #0 Phillips screwdriver.

* L1 and W1 actuators are not available in termination "S"

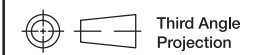

Dimensions are shown: Inch (mm)
Specifications and dimensions subject to change

KSD-CRD Series 10mm DIP Coded Rotary Switches



TERMINATIONS



DIP I

C PC, THRU-HOLE

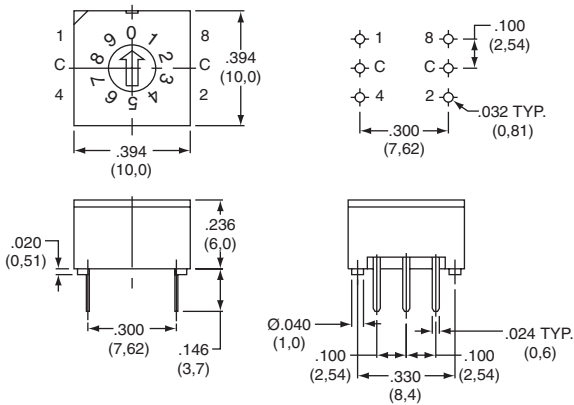

A RIGHT ANGLE, PC THRU-HOLE

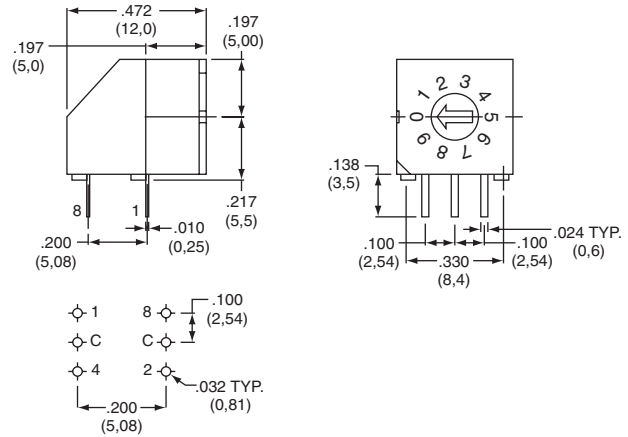

S SURFACE MOUNT

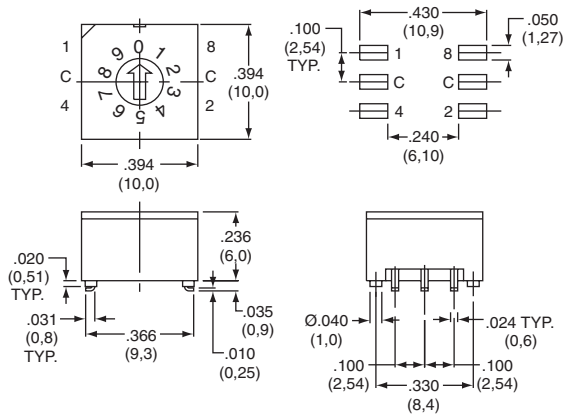

MO

CONTACT MATERIAL



OPTION CODE	RoHS COMPLIANT*	RoHS COMPATIBLE*	CONTACT MATERIAL	TERMINAL PLATING	RATING	
B	YES	YES	GOLD	GOLD	LOW LEVEL/DRY CIRCUIT	0.4 VC MAX. @ 20 V AC or DC MAX.

* Note: See Technical Data section of this catalog for RoHS compliant and compatible definitions and specifications.

TAPE & REEL

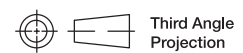
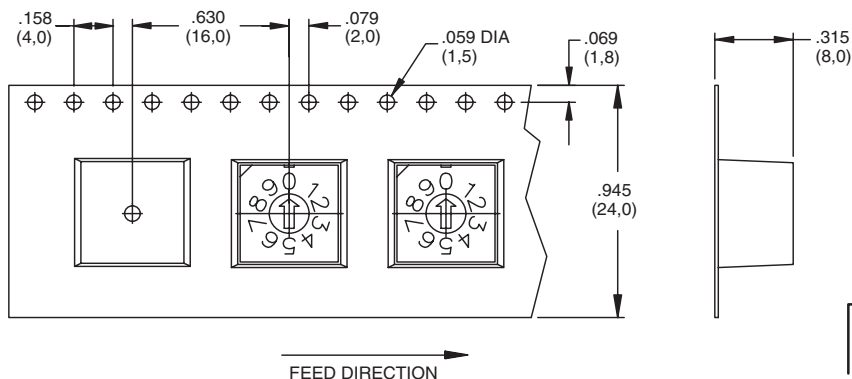

Dimensions are shown: Inch (mm)
Specifications and dimensions subject to change