



Feature :

Water proof IP67 sealed
Mini in dimension
SMD, right angle and vertical PCB terminal

Application :

Consumer products
Computer products
Instrumentation
Communication equipments



SWITCH SPECIFICATIONS	
POLE - POSITION	Momentary action , SPST
CONTACT RATING	12 V DC , 50 mA
CONTACT RESISTANCE	100 mΩ MAX. 5 V DC ; 1 A , by Method of Voltage DROP
INSULATION RESISTANCE	1000 MΩ MIN. 100 V DC for 1 minute
DIELECTRIC STRENGTH	Breakdown is not Allowable ; 250 V AC for 1 Minute
OPERATING FORCE	200 ± 80 gf ; 450 ± 150 gf
OPERATING LIFE	500,000 cycles
OPERATING TEMPERATURE RANGE	-40°C ~ 85°C
TOTAL TRAVEL	0.45 ± 0.15 mm
SEALING	IP67

▶ HOW TO ORDER

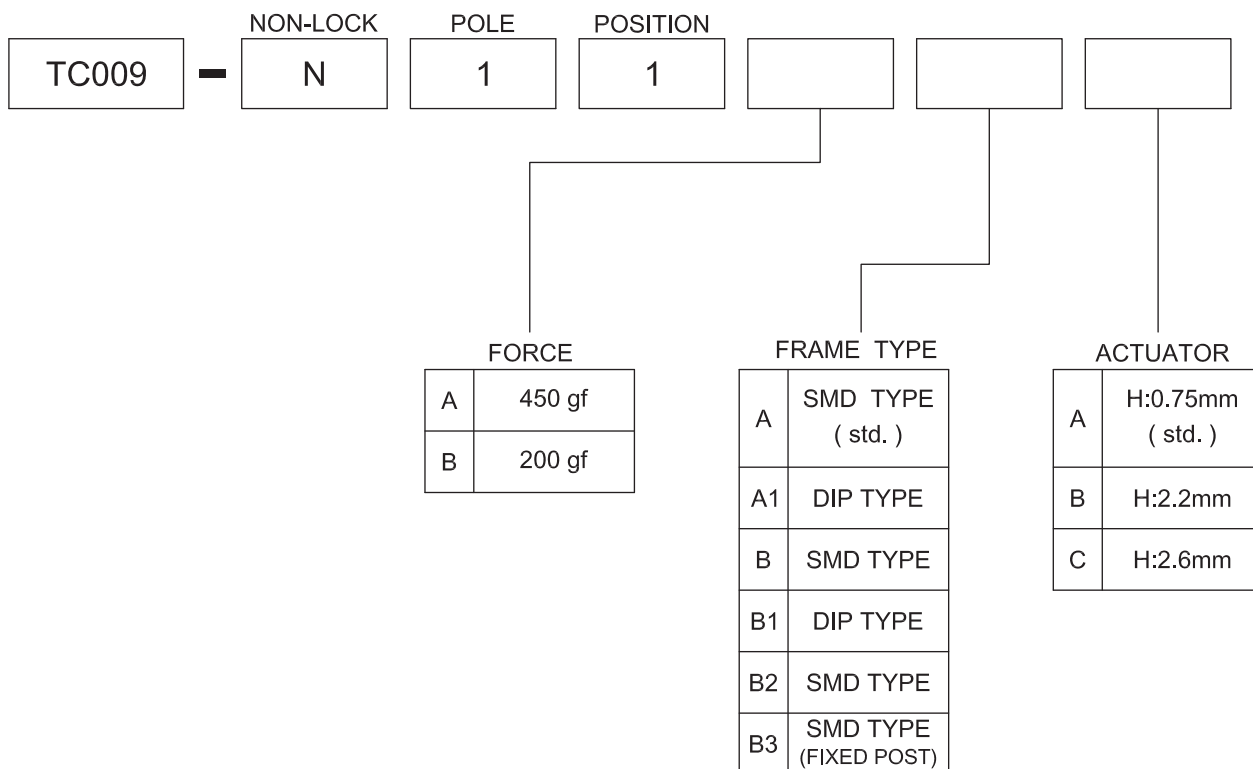

- TACT SWITCH
- PUSH BUTTON SWITCH
- LED TOUCH SENSOR SWITCH
- 5 DIRECTION NAVIGATION SWITCH WITH LED
- MEMBRANE SWITCH
- LED LIGHT BAR
- SLIDE SWITCH
- ROTARY SWITCH
- ROCKER SWITCH
- DETECT SWITCH
- ENCODER
- INTERRUPTER
- MINIATURE MICRO SWITCH
- TELEPHONE HOOK SWITCH
- DOOR SWITCH
- MINI SIZE SOCKET
- KNOB
- CAP SYMBOL



► DIMENSION

TC009-N11AAA

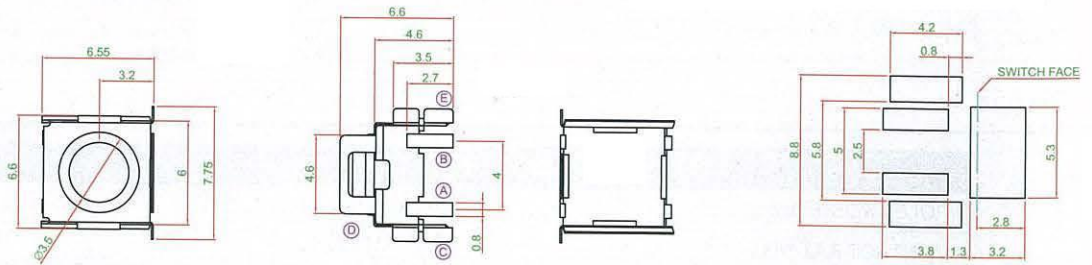

TC009-N11AA1B

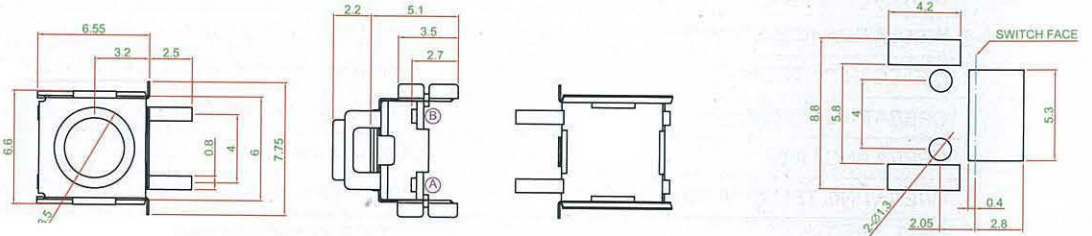

TC009-N11AB1B

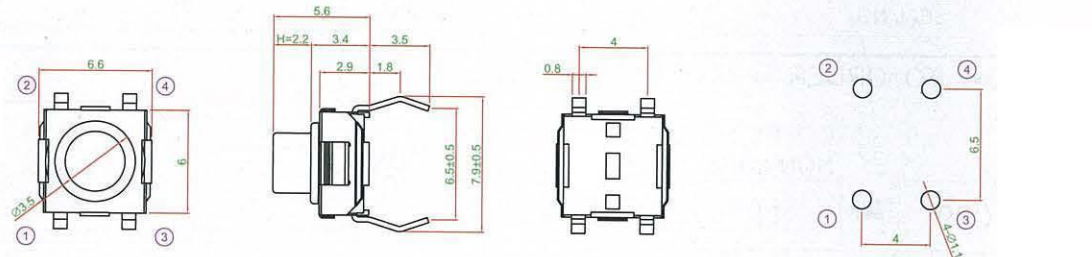

TC009-N11BBC

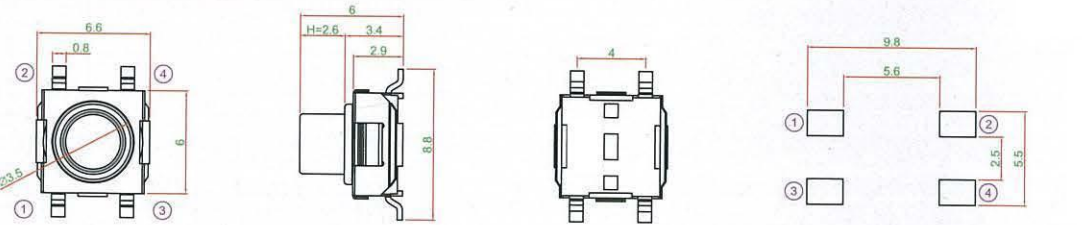

TC009-N11BB2C

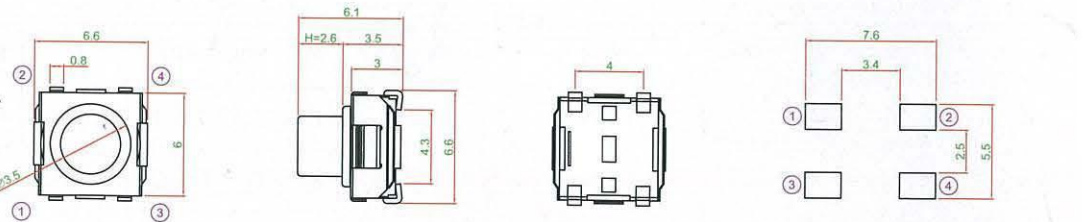

TC009-N11AB3A

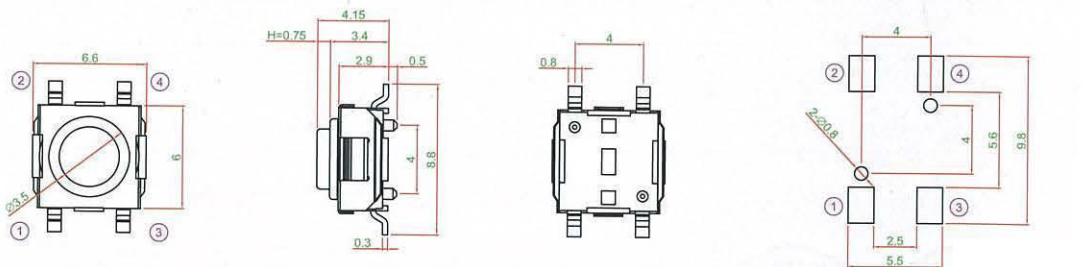

► CIRCUIT

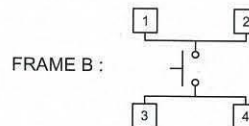
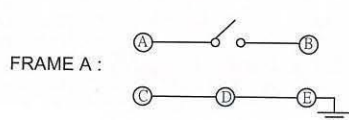

TACT SWITCH
PUSH BUTTON
LED TOUCH SENSOR
5 DIRECTION NAVIGATION SWITCH
MEMBRANE SWITCH
LED LIGHT
SLIDE SWITCH
ROTARY SWITCH
ROCKER SWITCH
DETECT SWITCH
ENCODER
INTERFILL TYPE
MINIATURE MICRO SWITCH
TELEPHONE HOOK
DOOR SWITCH
MINI SIZE SWITCH
CAP