



Feature :

Compact size  
Reflow soldering available

Application :

Consumer products  
Computer products  
Instrumentation  
Communication equipments  
Hand-held devices

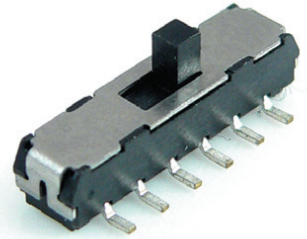

SWITCH SPECIFICATIONS	
POLE - POSITION	4P2T
CONTACT RATING	6 V DC , 0.3 A
CONTACT RESISTANCE	70 mΩ MAX. 5 V DC ; 1 A , by Method of Voltage DROP
INSULATION RESISTANCE	100 MΩ MIN. 500 V DC for 1 minute
DIELECTRIC STRENGTH	Breakdown is not Allowable ; 500 V AC for 1 Minute
OPERATING FORCE	200 ± 150 gf
OPERATING LIFE	10,000 cycles
OPERATING TEMPERATURE RANGE	-40°C ~ 85°C
TOTAL TRAVEL	2.0 ± 0.3 mm

► HOW TO ORDER

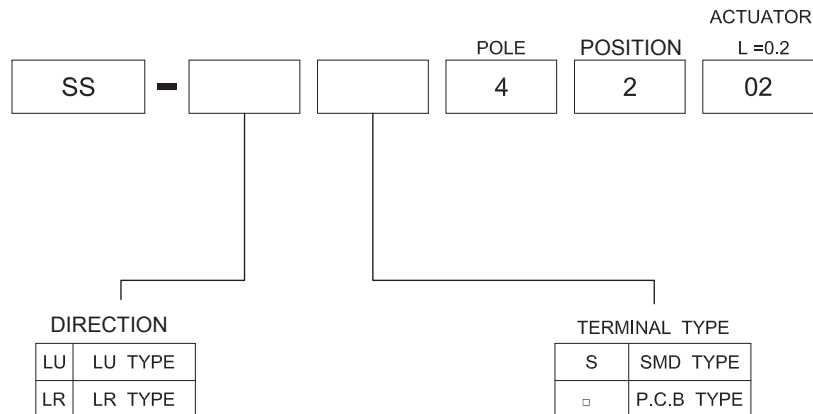

- TRACT SWITCH
- PUSH BUTTON SWITCH
- LED TOUCH SENSOR SWITCH
- 5 DIRECTION NAVIGATION SWITCH WITH LED
- MEMBRANE SWITCH
- LED LIGHT BAR
- SLIDE SWITCH
- ROTARY SWITCH
- ROCKER SWITCH
- DETECT SWITCH
- ENCODER
- INTERRUPTER
- MINIATURE MICRO SWITCH
- TELEPHONE HOOK SWITCH
- DOOR SWITCH
- MINI SIZE SOCKET
- KNOB
- CAP SYMBOL



► **DIMENSION**

SS-LUS4202

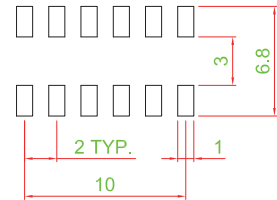
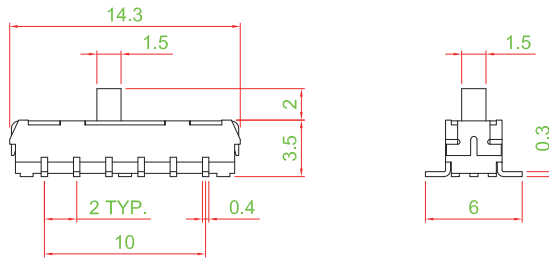
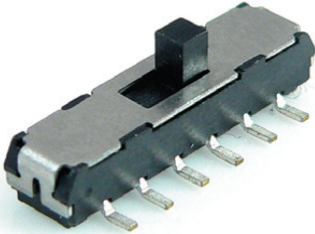

SS-LRS4202

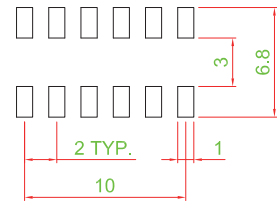
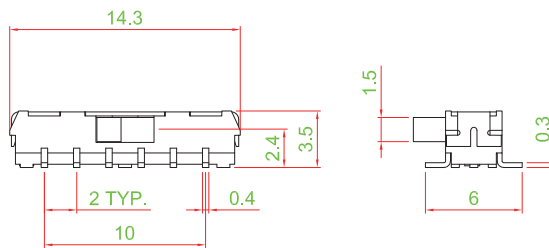
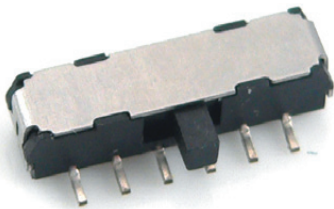

SS-LU4202

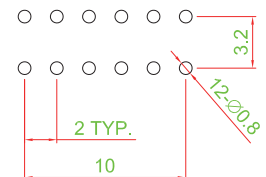
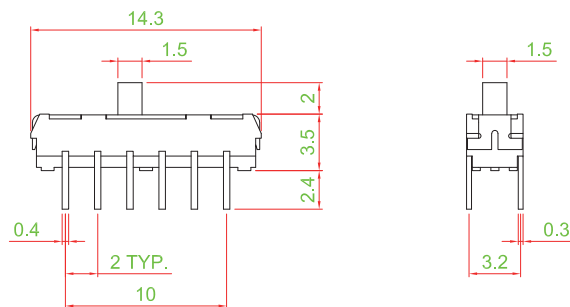
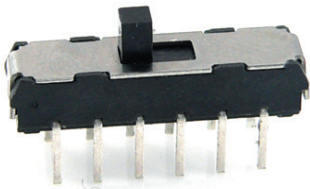

SS-LR4202

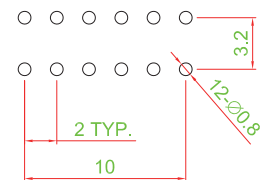
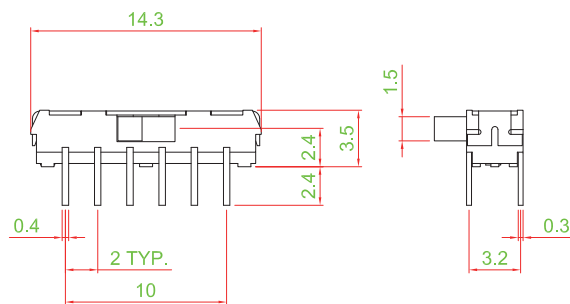
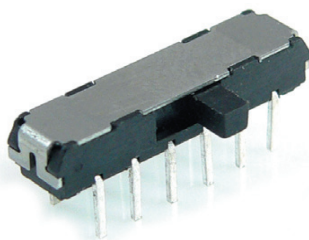

► **CIRCUIT**

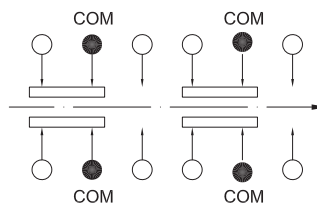

TACT SWITCH

PUSH BUTTON SWITCH

LED TOUCH SENSOR SWITCH

5 DIRECTION NAVIGATION SWITCH WITH LED

MEMBRANE SWITCH

LED LIGHT BAR

SLIDE SWITCH

ROTARY SWITCH

ROCKER SWITCH

DETECT SWITCH

ENCODER

INTERRUPTER

MINIATURE MICRO SWITCH

TELEPHONE HOOK SWITCH

DOOR SWITCH

MINI SIZE SOCKET

KNOB

CAP SYMBOL