

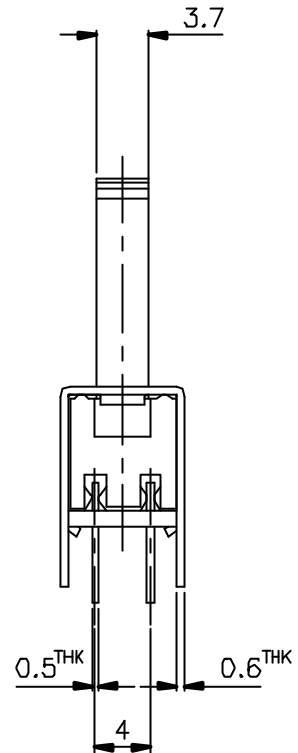

SCHEMATIC

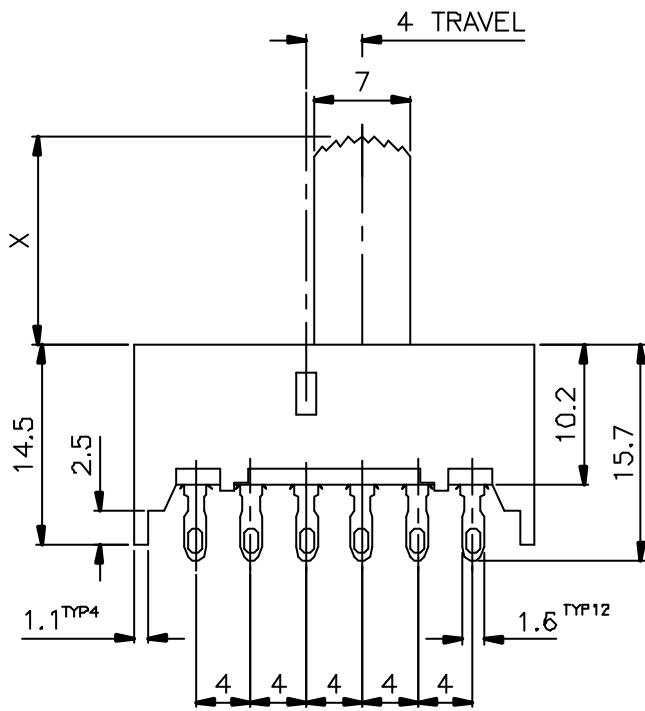
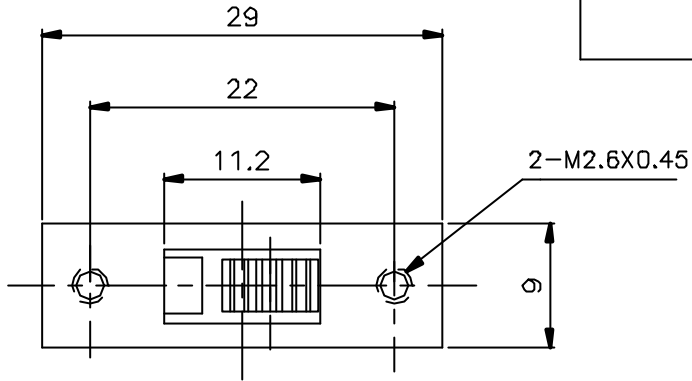

X=

ISSUED	SPECIFICATION (INITIAL)	TITLE: SLIDE SWITCH 4P2T	
	RATING: DC 50V 0.5A	MODEL NO: SS-42H04-G	
	CONTACT RESISTANCE: Not more than 30mΩ	UNIT: m m	DWN
	INSULATION RESISTANCE: 500MΩ at 500V DC	SCALE: 2 : 1	CHK'D
	WITHSTAND VOLTAGE: AC 500V for 1 min	TOLERANCE: ±0.2	APPD.
	OPERATION FORCE: 450±250g		
	SWITCHING LIFE: 10000cycles(6-10c/m loading)		
BY:	 广东科斯达电子科技有限公司 GUANG DONG KE SI DA ELECTRONIC TECHNOLOGY CO., LTD.	DRWG NO:	
DATE:		B 800850-00	