

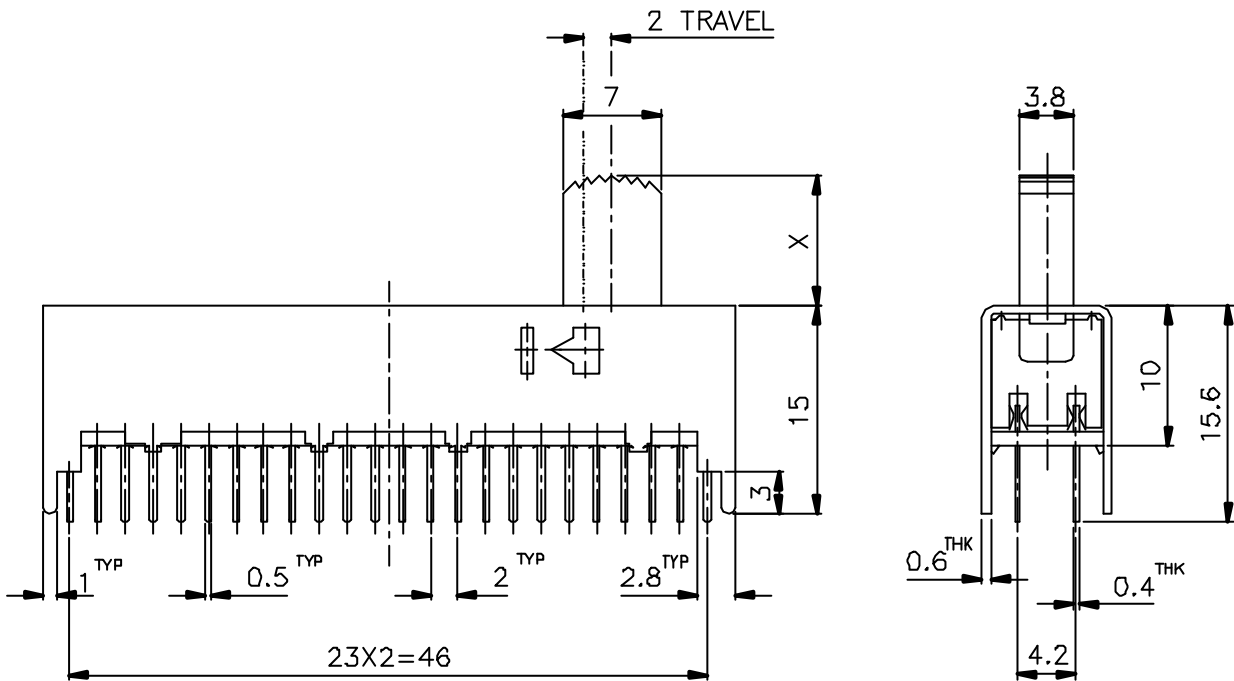

SCHEMATIC

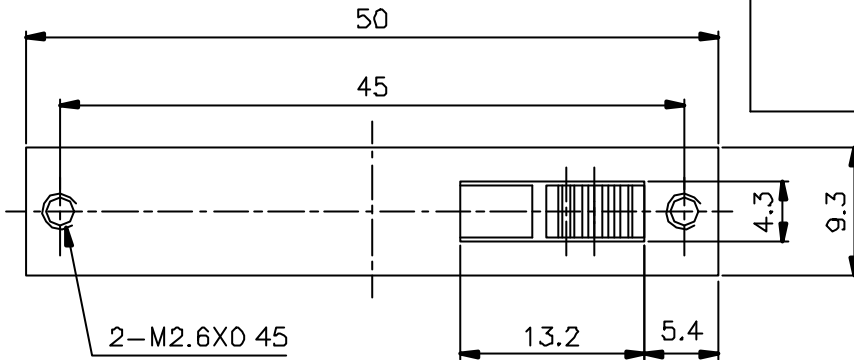

X=

ISSUED	SPECIFICATION (INITIAL)	TITLE: SLIDE SWITCH 8P4T		
	RATING: DC 50V 0.5A	MODEL NO: SS-84D01-G		
	CONTACT RESISTANCE: Not more than 30mΩ	UNIT: mm	DWN	
	INSULATION RESISTANCE: 500MΩ at 500V DC	SCALE: 2 : 1	CHK'D	
	WITHSTAND VOLTAGE: AC 500V for 1 min	TOLERANCE: ±0.20	APPD.	
	OPERATION FORCE: 450±200g			
	SWITCHING LIFE: 10000 Cycles (6-10c/m loading)			
BY:	 广东科斯达电子科技有限公司 GUANG DONG KE SI DA ELECTRONIC TECHNOLOGY CO., LTD.	DRWG NO:		
DATE:		970270-00		