

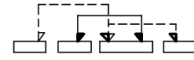

**KSD**

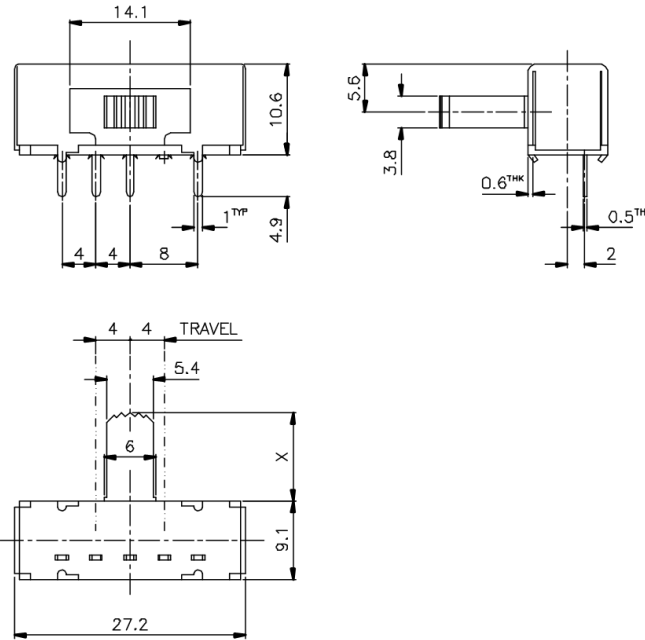

SCHEMATIC



X=

ISSUED	SPECIFICATION (INITIAL)	TITLE: SLIDE SWITCH 1P3T
	RATING: DC 50V 0.5A	MODEL NO: SK-13H05-G
	CONTACT RESISTANCE: Not more than 30mΩ	UNIT: mm DWN
	INSULATION RESISTANCE: 500MΩ at 500V DC	SCALE: 2 : 1 CHK'D
	WITHSTAND VOLTAGE: AC 500V for 1 min	TOLERANCE: ±0.2 APPD.
	OPERATION FORCE: 400±250g	
	SWITCHING LIFE: 10000cycles(6-10c/m loading)	
BY:	 <b>广东科斯达电子科技有限公司</b> GUANG DONG KE SI DA ELECTRONIC TECHNOLOGY CO., LTD.	DRWG NO:
DATE:		830262-00